

刀柄 TOOLING SYSTEM

BT50 HSK-A63 HSK-A100 DN50 CT50

创新实现最优化

BT50 10,000 min⁻¹
 HSK-A63 20,000 min⁻¹
 HSK-A100 10,000 min⁻¹
 DN50 10,000 min⁻¹
 CT50 10,000 min⁻¹

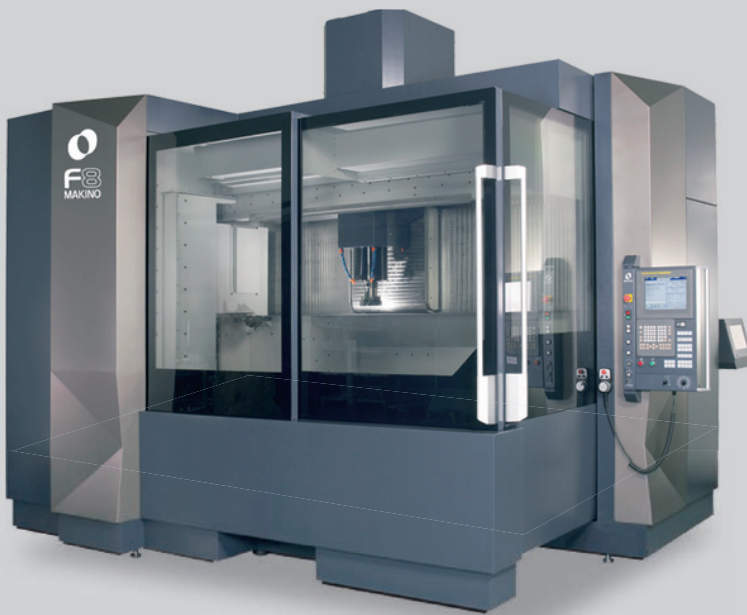

热装式刀柄 **SLIMLINE**
 SHRINK-FIT HOLDER SLIMLINE



2体型 直柄延长杆 一体型
 2 PIECE- STRAIGHT MONO
 modular arbor series
 P.3 P.6 P.8

袖珍型
 角度头
 ANGLE HEAD
 HALF



P.19

DETa-1 超弹性筒夹刀柄
 DETa-1 COLLET HOLDER



P.22



热装专用特殊不锈钢

SPECIAL MATERIAL

- 热膨胀系数是通常普通钢的1.6倍
Its thermal expansion coefficient is 1.6 times higher than that of regular steel.
- 用温风式加热器即可进行热装卸操作
Shrink fitting and removing is achieved using a hot-air heater.
- 可以放入水中进行冷却
Can be immersed in water to cool it off.
- 使用温风式加热器加热, 不会出现加热过度
Will not overheat even if heated for a long time.
- 前端壁厚仅为1.5mm的超薄设计和丰富的刀柄种类
Ultra-thin 1.5 mm(.06") edge walls and sufficient variations of holder shapes.
- 不用更换加热喷嘴就可以进行 $\phi 3 \sim \phi 25$ 的热装
Available from dia 3mm to dia 25mm(.12"~1") with just one nozzle.

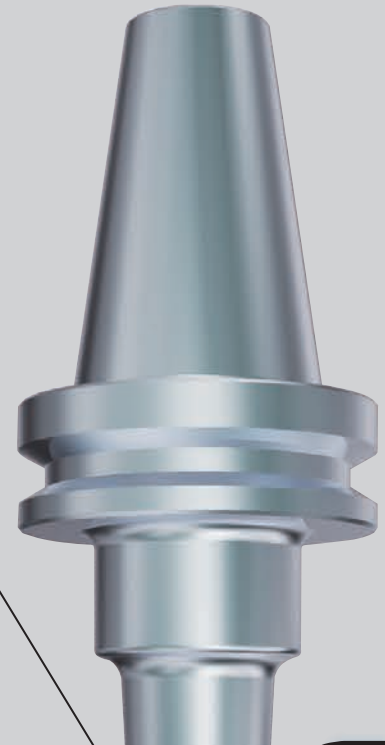

半角 3°
Single Angle

硬质合金刀具

Required Carbide Cutter

$\phi 3 \sim 5 \rightarrow h6$ / $\phi 6 \sim 25 \rightarrow h7$
(1/8"~1/4") (5/16"~1")

可以使用市售 $\phi 3$ (.12") 以上的刀具
Commercially cutting tools are available for dia. 3mm(.12").



加热喷嘴
Nozzle

温风式加热器
HOT AIR HEATER

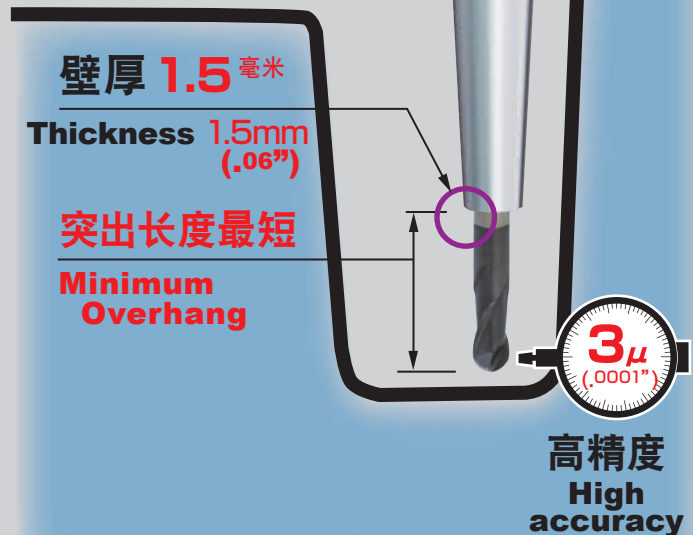

壁厚 1.5 毫米

Thickness 1.5mm
(.06")

突出长度最短

Minimum Overhang

3 μ
(.0001")

高精度
High accuracy

本体

Master Holder



A63-SLK12-75F

Fig. 1

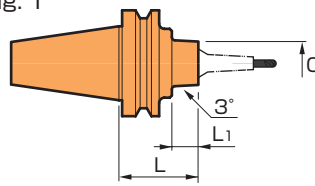

Fig. 2

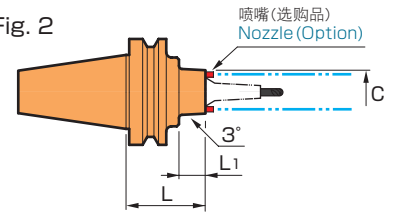

Fig. 3

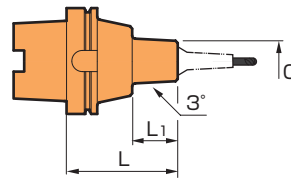
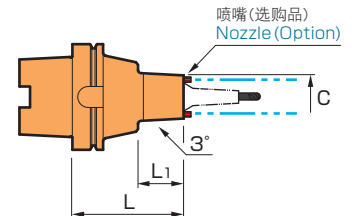

Fig. 4



CODE	Fig.	L	φC	L1	Kg (lbs)	
BT BT50 -SLK12- 75	1	75	38	25	4.0	
	2		41			
		- 75F	105		55	4.4
		-105F	135		85	4.7
		-135F	225	38	150	6.4
-315	1	315			11.0	
HSK A 63 -SLK12- 75	3	75	38	49	1.0	
	4		41		1.1	
		- 75F	135	38	109	1.7
	4			41		1.9
		-135F	105	38	43	3.4
DIN A100 -SLK12-105	3	105	38	43	3.4	
	4		41		3.5	
		-105F	135		73	3.8
	3	225	38	163	5.4	
		-315	315		150	6.4
CAT. DN50AD-SLK12- 75	1	75	38	40	3.4	
	2				3.5	
		- 75F	135	41	100	4.3
1	75 (2.95")	38 (1.50")	40 (1.57")	3.3 (7.3)		

- 选购品
- SLIMLINE筒夹
- 内六角扳手
- 喷嘴
- 拉钉
- 冷却液导管 (HSK-A)
- 标准附属品
- 关于拉钉的更换请向弊司垂询。
- 备考
- SLIMLINE collet
- Wrench
- Nozzle
- Retention knob
- Coolant duct (HSK-A)
- Standard accessories
- Note
- To replace the extension knob, please contact us.

六角扳手

Wrench

用于拧紧本体和 SLIMLINE筒夹。
Required for clamping the main body and SLIMLINE collet.

CODE
W-135

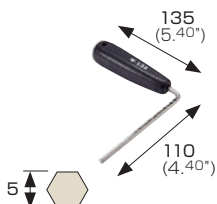

喷嘴

Nozzle

CODE	数量 Q'ty
NOZ-M4-12	12
-60	60

- 补充说明
- 每个本体需要4个
- Note
- Four nozzles are required for each master holder.

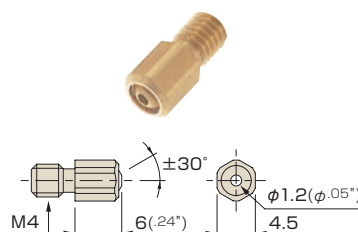

刀柄台

Holder stand

SLIMLINE筒夹、直柄刀杆、HSK-E25、E32用刀柄筒夹台。
有4种颜色可供选择,可按颜色分类整理,使用方便。

This is a stand for SLIMLINE collets, STRAIGHT arbor and compact holders (HSK-E25, E32). Selectable from four colors. Convenient to make arrangements by color-coding, etc.

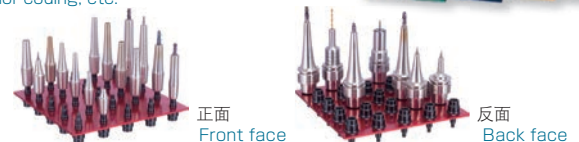

CODE	色 Colors	正面 Front face	反面 Back face	放置个数 Storage capacity
SDKT-RE	红 Red	SLIMLINE 筒夹	小径刀柄	各 25 支 25 pieces each
-BL	蓝 Blue	SLIMLINE 筒夹	小径刀柄	
-GR	绿 Green	直柄刀杆	直柄刀杆	
-GD	金 Gold	Straight arbor	直柄刀杆 (HSK-E25/E32)	

开孔拉钉

如果拉钉孔在 φ6 以上,可以在装载拉钉的情况下进行拧紧

Retention knob with hole

There is no need to remove a retention knob with .24" (6mm) diameter coolant-thru hole when tightening or loosening SLIMLINE taper adapters.

开孔拉钉
Retention knob with hole



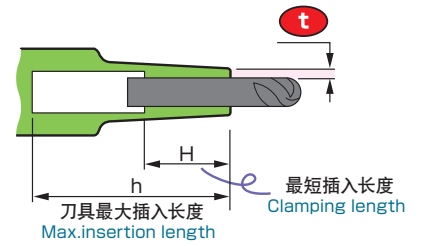
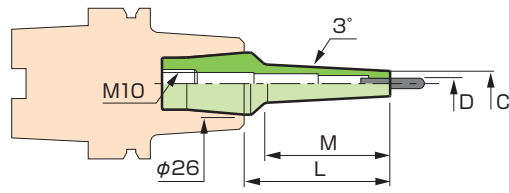

细长型

Slim-type

CODE	ϕD	ϕC	t	L	M	H	h
CS12- 3- 35	3	6	1.5	35	22	10	65
- 55				55	42		85
- 80				80	67		110
-110				110	97		140
CS12-3.175- 35	3.175	6.175	1.5	35	22	10	65
- 55				55	42		85
- 80				80	67		110
-110				110	97		140
CS12- 4- 35	4	7	1.5	35	22	12	65
- 55				55	42		85
- 80				80	67		110
-110				110	97		140
CS12- 5- 35	5	8	1.5	35	22	15	65
- 55				55	42		85
- 80				80	67		110
-110				110	97		140
CS12- 6- 35	6	9	1.5	35	22	18	65
- 55				55	42		85
- 80				80	67		110
-110				110	97		140
CS12- 7- 35	7	10	1.5	35	22	20	65
- 55				55	42		85
- 80				80	67		110
-110				110	97		140
CS12- 8- 35	8	11	1.5	35	22	25	65
- 55				55	42		85
- 80				80	67		110
-110				110	97		140
CS12- 9- 35	9	12	1.5	35	22	30	60
- 55				55	42		
- 80				80	67		
-110				110	97		
CS12-10- 35	10	13	1.5	35	22	30	60
- 55				55	42		
- 80				80	67		
-110				110	97		
CS12-11- 35	11	14	1.5	35	22	30	60
- 55				55	42		
- 80				80	67		
-110				110	97		
CS12-12- 35	12	15	1.5	35	22	30	60
- 55				55	42		
- 80				80	67		
-110				110	-		

标准型

Regular-type

CODE	ϕD	ϕC	t	L	M	H	h
CR12- 3-35	3	7.5	2.25	35	22	10	65
-55				55	42		85
-80				80	67		110
CR12- 4-35	4	10	3	35	22	12	65
-55				55	42		85
-80				80	67		110
CR12- 6-35	6	12	3	35	22	18	65
-55				55	42		85
-80				80	67		110
CR12- 8-35	8	14	3	35	22	25	65
-55				55	42		85
-80				80	67		110
CR12-10-35	10	16	3	35	22	30	60
-55				55	42		
-80				80	67		
CR12-12-35	12	20	4	35	22	30	60
-55				55	42		
-80				80	-		

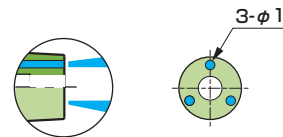

油孔型

Flush-type

CODE	ϕD	ϕC	t	L	M	H	h
CF12- 3-35	3	9.5	3.25	35	22	10	65
-55				55	42		85
-80				80	67		110
CF12- 4-35	4	12	4	35	22	12	65
-55				55	42		85
-80				80	67		110
CF12- 6-35	6	14	4	35	22	18	65
-55				55	42		85
-80				80	67		110
CF12- 8-35	8	16	4	35	22	25	65
-55				55	42		85
-80				80	67		110
CF12-10-35	10	18	4	35	22	30	60
-55				55	42		
-80				80	-		
CF12-12-35	12	20	4	35	22	30	60
-55				55	42		
-80				80	-		

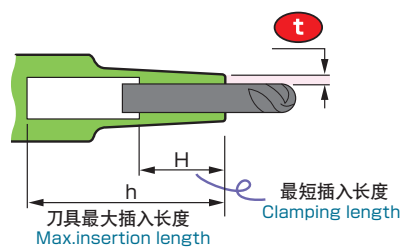
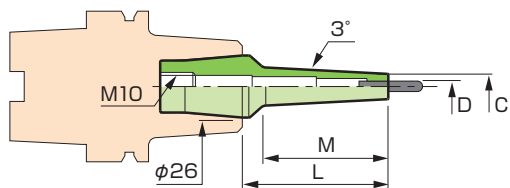

细长型

Slim-type

CODE	φD	φC	t	L	M	H	lbs	h
CS12-1/ 8- 80	.1250	.24	.059	3.15	2.64	.38	0.40	4.33
-110				4.33	3.82		0.48	5.51
-3/16- 80	.1875	.31		3.15	2.64	.58	0.41	4.33
-110				4.33	3.82		0.51	5.51
-1/ 4- 80	.2500	.37		3.15	2.64	.70	0.44	4.33
-110				4.33	3.82		0.56	5.51
-5/16- 80	.3125	.43		3.15	2.64	.98	0.47	4.33
-110				4.33	3.82		0.61	5.51
-3/ 8- 80	.3750	.49		3.15	2.64	1.18	0.50	2.36
-110				4.33	3.82		0.66	
-1/ 2- 80	.5000	.62		3.15	2.64		0.55	
-110				4.33	3.82		0.77	

标准型

Regular-type

CODE	φD	φC	t	L	M	H	lbs	h
CR12-1/ 8- 55	.1250	.36	.089	2.17	1.65	.38	0.41	3.35
-3/16- 55	.1875	.42	.119			.46	0.42	
-1/ 4- 55	.2500	.49				.70	0.44	
-5/16- 55	.3125	.55				.98	0.45	
-3/ 8- 55	.3750	.61		1.65	1.18	0.47	2.36	
-1/ 2- 35	.5000	.81	.157	1.38	.87		0.40	
- 55				2.17	1.99		0.54	

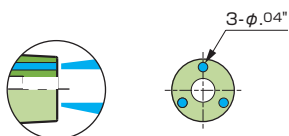

油孔型

Flush-type

CODE	φD	φC	t	L	M	H	lbs	h
CF12-1/ 8- 55	.1250	.38	.128	2.17	1.65	.39	0.42	3.35
-3/16- 55	.1875	.50	.157			.55	0.46	
-1/ 4- 55	.2500	.56				.71	0.47	
-3/ 8- 55	.3750	.69				1.18	0.51	
-1/ 2- 55	.5000	.81				1.99	0.54	

Metric
公制

CODE	Fig.	φD	φC	t	L	M	φD1	H	L1	最大夹持长度 Max. insertion length	Kg
ST10 -SLSA 3- 80-M 35	1	3	6	1.5	80	35	10	9	45	64	0.03
ST16 -SLRA 3- 90-M 22	2		7.5	2.25	90	22	16		60	62	0.09
-SLSA 3-115-M 42			6	1.5	115	42				87	
-SLRA 3-115-M 42			7.5	2.25					65		0.1
-SLSA 3-140-M 67			6	1.5	140	67			60	112	
-SLRA 3-140-M 67			7.5	2.25					65		
ST10C -SLSA 3-160	3		6	1.5	160	12	10		120	19	0.2
ST20 -SLRA 3-175-M 97	2		7.5		175	97	20		70	147	
-SLSA 3-200-M 97			6	1.5	200				90	172	0.3
ST25 -SLSA 3-245-M 97					245		25		120	217	0.6
-SLRA 3-245-M 97			7.5	2.25							
ST16C -SLSA 3-280	3		6	1.5	280	12	16		182	19	0.7
ST25 -SLSA 3-315-M195	1			1.5	315	195	25		120	287	
-SLRA 3-315-M 67	2		7.5	2.25		67			220		0.9
ST10 -SLSA3.175 - 80-M35	1	3.175	6.175	1.5	80	35	10	10	45	64	0.03
ST10 -SLSA 4- 80-M 35	1		7	1.5	80	35	10	12	45	64	0.03
ST16 -SLRA 4- 90-M 22	2		10	3	90	22	16		60	62	0.09
-SLSA 4-115-M 42			7	1.5	115	42				87	0.1
-SLRA 4-115-M 42			10	3					65		
-140-M 60	1				140	60			80	112	
-SLSA 4-140-M 67	2		7	1.5		67			60		
ST10C -SLSA 4-160	3			1.5	160	12	10		120	19	0.2
ST20 -SLRA 4-175-M 95	1		10	3	175	95	20		80	147	0.3
-SLSA 4-200-M 97	2		7	1.5	200	97			90	172	
ST25 -SLSA 4-245-M 97					245		25		120	217	0.6
-SLRA 4-245-M 97			10	3							
ST16C -SLSA 4-280	3		7	1.5	280	12	16		182	19	0.7
ST25 -SLRA 4-315-M 67	2		10		315	67	25		220	287	0.9
-SLSA 4-315-M195	1		7	1.5		195			120		0.7
ST10 -SLSA 5- 80-M 35	1	5	8	1.5	80	35	10	15	45	70	0.03
ST20 -SLSA 5-200-M110					200	110	20		90	182	0.3
ST25 -SLSA 5-290-M 97	2				290	97	25		180	272	0.8
ST12 -SLSA 6- 80-M 35	1	6	9	1.5	80	35	12	18	45	52	0.04
ST16 -SLSA 6-115-M 42	2				115	42	16		60	87	0.1
-SLSB 6-115-M 42			10	2					65		
ST20 -SLRB 6-120-M 42			14	4	120		20		70	92	0.2
ST16 -SLSB 6-140-M 60	1		10	2	140	60	16		80	112	0.1
-SLSA 6-140-M 70			9	1.5		70			70		
ST20 -SLSA 6-175-M105					175	105	20			147	0.3
-SLSB 6-175-M 95			10	2		95			80		
-SLRB 6-175-M 60			14	4		60			115		
ST12C -SLSB 6-175	3		10	2		12	12		125	27	
ST25 -SLSB 6-205-M127	2		2	205	127	25			70	177	0.5
ST16C -SLSB 6-225	3		2	225	22	16			165	32	0.6
ST25 -SLSA 6-230-M 97	2		9	1.5	230	97	25		120	202	0.5
-SLRB 6-240-M 42			14	4	240	42			170	212	0.7
ST32 -SLSB 6-255-M157			10	2	255	157	32		70	227	0.8
ST25 -SLSA 6-305-M185	1		9	1.5	305	185	25		120	277	
ST20C -SLSB 6-320	3		10	2	320	22	20		221	32	1.3
ST32 -SLRB 6-345-M 67	2		14	4	345	67	32		250	317	1.6
ST25C -SLSB 6-360	3		10	2	360	22	25		242	38	2.2
ST32 -SLSB 6-375-M157	2		2	375	157	32			190	347	1.4
ST25 -SLSA 7-230-M 97	2	7	10	1.5	230	97	25	20	120	212	0.5
-320-M 97					320				210	302	0.9
ST20 -SLRB 8-100-M 30	1	8	18	5	100	30	20	24	70	72	0.2
ST16 -SLSA 8-115-M 50			11	1.5	115	50	16		65	87	0.1
ST20 -SLSB 8-145-M 70			13	2.5	145	70	20		75	117	0.2
ST25 -SLRB 8-160-M 42	2		18	5	160	42	25		110	132	0.5
ST20 -SLSA 8-175-M 85	1		11	1.5	175	85	20		90	147	0.3
ST25 -SLSB 8-175-M 97	2		13	2.5		97	25		70		0.4
-SLRB 8-210-M 90	1		18	5	210	90			120	182	0.6

Fig. 1

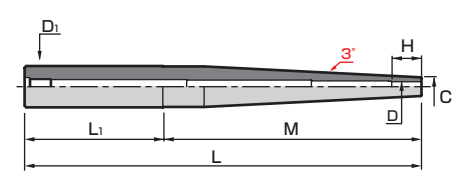

Fig. 2

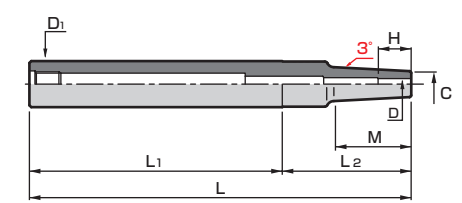
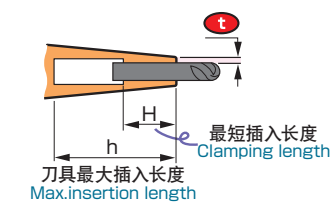
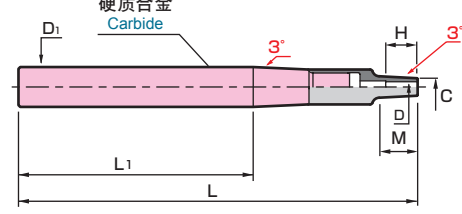

Fig. 3



CODE	Fig.	φD	φC	t	L	M	φD1	H	L1	最大夹持长度 Max. insertion length	Kg		
ST16C-SLSB 8-225	3	8	13	2.5	225	22	16	24	165	32	0.6		
ST25 -SLSA 8-230-M 97	2		11	1.5	230	97	25		120	202			
-SLSB 8-260-M140	1		13	2.5	260	140				232	0.7		
ST20C-SLSB 8-270	3			2.5	270	22	20			200	38	1.1	
ST25 -SLSA 8-280-M160	1			11	1.5	280	160		25	120	252	0.7	
ST32 -SLRB 8-285-M 67	2			18	5	285	67		32	190	257	1.3	
ST25C-SLSB 8-360	3			13	2.5	360	22		25	242	38	2.2	
ST32 -SLSB 8-375-M157	2				2.5	375	157		32	190	347	1.5	
ST25 -SLSA 9-230-M 97	2	9	12	1.5	230	97	25	30	120	60	0.6		
-320-M 97					320					210		0.9	
ST25 -SLRB10-120-M 35	1	10	22	6	120	35	25	30	85	60	0.4		
ST20 -SLSB10-120-M 50			16	3		50	20			70		0.2	
ST25 -SLSB10-145-M 67	2				145	67	25					0.4	
ST20 -SLSA10-145-M 70	1			13	1.5		70		20		75	0.2	
ST25 -SLSB10-175-M105				16	3	175	105		25		70	0.5	
-SLRB10-210-M 90				22	6	210	90				120	0.7	
ST32 -SLSB10-240-M170				16	3	240	170		32		70	212	0.9
ST25 -SLSA10-255-M135				13	1.5	255	135		25		120	60	0.7
ST20C-SLSB10-270	3			16	3	270	22		20		200	38	1.1
ST25 -SLSB10-275-M105	1				3	275	105		25		170	60	0.8
ST32 -SLRB10-285-M 67	2			22	6	285	67		32		190	257	1.4
-SLSA10-340-M210	1			13	1.5	340	210				130	312	1.3
ST25C-SLSB10-360	3			16	3	360	22		25		242	38	2.2
ST32 -SLSB10-360-M170	1				3		170		32		190	332	1.5
ST42 -SLSB10-445-M157	2					445	157		42		260	417	2.7
ST25 -SLSA11-230-M110	1		11	14	1.5	230	110		25	30	120	60	0.6
-320-M110					320				210			0.9	
ST25 -SLSB12-120-M 42	2	12	19	3.5	120	42	25	30	70	60	0.3		
ST20 -SLSA12-120-M 50	1			15	1.5		50		20			0.2	
ST32 -SLRB12-140-M 60				26	7	140	60		32		80	112	0.7
ST25 -SLSB12-150-M 80				19	3.5	150	80		25		70	60	0.4
ST32 -SLSB12-220-M150						220	150		32			192	0.9
ST25 -SLSA12-230-M110				15	1.5	230	110		25		120	60	0.6
-SLSB12-250-M 80				19	3.5	250	80				170		0.8
ST32 -SLRB12-260-M 70				26	7	260	70		32		190	232	1.3
-SLSA12-315-M185				15	1.5	315	185				130	287	1.2
-SLSB12-340-M150				19	3.5	340	150				190	312	1.5
ST42 -SLSB12-445-M157	2					445	157		42		260	417	2.8
ST32 -SLRB16-175-M 45	1		16	32	8	175	45		32	32	130	80	0.8
ST25 -SLSB16-175-M 50		24		4		50	25		125			0.5	
ST32 -SLSB16-290-M100					290	100	32		190			1.4	
ST42 -SLRB16-355-M 67	2			32	8	355	67	42			260	327	2.7
-SLSB16-445-M157	1		24	4	445	157				417	3.0		
ST42 -SLRB20-170-M 70	1	20	38	9	170	70	42	40	100	142	1.3		
ST32 -SLSB20-175-M 50				29	4.5	175	50		32		125	80	0.8
ST42 -SLSB20-255-M155						255	155		42		100	227	1.7
-SLRB20-330-M 70				38	9	330	70				260	302	2.6
-SLSB20-415-M155				29	4.5	415	155					387	2.9
ST42 -SLRB25-170-M 42	2	25	45	10	170	42	42	45	100	80	1.5		
-SLRB25-250-M 42						250					180		2.1

Inch
英制

CODE	Fig.	φD	φC	t	L	M	φD1	H	L1	Max. insertion length	lbs	
ST19.05-SLS1/ 8-200	2	.1250	.24	.059	7.87	3.82	.750	.38	3.54	7.20	0.62	
-SLS3/16-200	1	.1850	.31				4.33		.59			0.55
-SLS1/ 4-200		.2500	.37				3.94		.71	3.94		
ST25.4 -SLS3/ 8-230	2	.3750	.49		9.06	3.82	1.000	1.18	4.72	2.36	1.43	
-SLS1/ 2-230	1	.5000	.62			4.33					1.33	

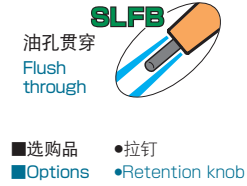
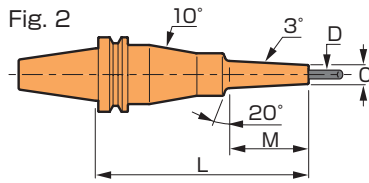
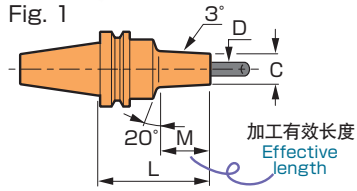
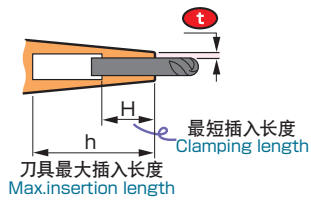

HEATROBO电磁式加热器对应表
 ○: 可加热 ×: 不可加热
 ▲: 请将刀柄直接放在定位板上→P.15

Available holder list for heat robo
 ○: Available ×: Not available
 ▲: Set up the holder on the positioning plate directly. →P.15

CODE	Fig.	φD	φC	L	M	H	h	Kg	
BT50-SLSA3-110-M 42	1	3	6	110	42	9	165	3.6	○
-135-M 67				135	67		190	3.7	
-140-M 42				140	42		195		
-165-M 67				165	67		220		
t=1.5 -M 97					97				
-170-M 42	2			170	42		225	4.1	
-195-M 67				195	67		250		
-M 97	1				97			3.8	
-225-M 97	2			225			280	4.1	
-SLRA3- 90-M 22	1	3	7.5	90	22	9	145	3.6	
-110-M 42				110	42		165	3.7	
-120-M 22				120	22		175		
-135-M 67				135	67		190		
-140-M 42				140	42		195	3.8	
-150-M 22	2			150	22		205	4.0	
-165-M 67	1			165	67		220	3.8	
t=2.25 -M 97					97			3.7	
-170-M 42	2			170	42		225	4.1	
-195-M 67				195	67		250		
-M 97	1				97			3.8	
-M127					127				
-225-M 97	2			225	97		280	4.1	
-M127	1				127				
-255-M127	2			255			310	4.4	
-SLFB3- 90-M 22	1	3	9.5	90	22	9	145	3.6	
-110-M 42				110	42		165	3.7	
-120-M 22				120	22		175	3.8	
-135-M 67				135	67		190	3.7	
t=3.25 -140-M 42				140	42		195		
-150-M 22	2			150	22		205	4.0	
-165-M 67	1			165	67		220	3.8	
-170-M 42	2			170	42		225	4.0	
-195-M 67				195	67		250	4.1	
-SLSA4-110-M 42	1	4	7	110	42	12	165	3.7	○
-135-M 67				135	67		190	3.6	
-140-M 42				140	42		195	3.7	
-165-M 67				165	67		220	3.8	
t=1.5 -M 97					97			3.7	
-170-M 42	2			170	42		225	4.0	
-195-M 67				195	67		250		
-M 97	1				97			3.8	
-225-M 97	2			225			280	4.1	

CODE	Fig.	φD	φC	L	M	H	h	Kg	
BT50-SLRA4- 90-M 22	1	4	10	90	22	12	145	3.6	○
-110-M 42				110	42		165	3.7	
-120-M 22				120	22		175		
-135-M 67				135	67		190		
-140-M 42				140	42		195	3.8	
-150-M 22	2			150	22		205	4.0	
-165-M 67	1			165	67		220	3.8	
t=3 -M 97					97				
-170-M 42	2			170	42		225	4.1	
-195-M 67				195	67		250		
-M 97	1				97			3.9	
-M127					127			3.8	
-225-M 97	2			225	97		280	4.2	
-M127	1				127			4.0	
-255-M127	2			255			310	4.4	
-SLFB4- 90-M 22	1	4	12	90	22	12	145	3.7	
-110-M 42				110	42		165		
-120-M 22				120	22		175		
-135-M 67				135	67		190		
t=4 -140-M 42				140	42		195	3.8	
-150-M 22	2			150	22		205	4.0	
-165-M 67	1			165	67		220	3.8	
-170-M 42	2			170	42		225	4.1	
-195-M 67				195	67		250	4.2	
-SLSA6-110-M 42	1	6	9	110	42	18	165	3.7	○
-135-M 67				135	67		190		
-140-M 42				140	42		195		
-165-M 67				165	67		220	3.8	
-M 97					97			3.7	
t=1.5 -170-M 42	2			170	42		225	4.1	
-195-M 67				195	67		250		
-M 97	1				97			4.0	
-225-M 97	2			225			280	4.3	
-SLSB6-110-M 42	1	6	10	110	42	18	165	3.7	
-135-M 67				135	67		190		
-140-M 42				140	42		195		
-165-M 67				165	67		220	3.8	
-M 97					97				
-170-M 42	2			170	42		225	4.0	
-195-M 67				195	67		250	4.1	
t=2 -M 97	1				97			3.9	
-M127					127			3.8	
-225-M 97	2			225	97		280	4.3	
-M127	1				127			4.0	
-M157					157			3.9	
-255-M127	2			255	127		310	4.4	▲
-M157	1				157			4.1	
-285-M157	2			285			340	4.5	
-SLRB6- 90-M 22	1	6	14	90	22	18	145	3.7	○
-110-M 42				110	42		165		
-120-M 22				120	22		175	3.8	
-135-M 67				135	67		190		
-140-M 42				140	42		195	3.9	
t=4 -150-M 22	2			150	22		205	4.2	
-165-M 67	1			165	67		220	3.9	
-170-M 42	2			170	42		225	4.5	
-195-M 67				195	67		250	4.3	
-SLFB6- 90-M 22	1	6	14	90	22	18	145	3.6	
-110-M 42				110	42		165	3.7	
-120-M 22				120	22		175	3.8	
-135-M 67				135	67		190		
t=4 -140-M 42				140	42		195	3.9	
-150-M 22	2			150	22		205	4.2	
-165-M 67	1			165	67		220	3.9	
-170-M 42	2			170	42		225	4.3	
-195-M 67				195	67		250	4.5	

CODE	Fig.	φD	φC	L	M	H	h	Kg	
BT50-SLSA 8-110-M 42	1	8	11	110	42	24	165	3.6	○
-135-M 67				135	67		190	3.7	
-140-M 42				140	42		195	3.9	
-165-M 67				165	67		220		
t=1.5 -M 97					97			3.8	
-170-M 42	2			170	42		225	4.0	
-195-M 67				195	67		250	4.5	
-M 97	1				97			4.0	
-225-M 97	2			225			280	4.5	
-SLSB 8-110-M 42	1	8	13	110	42	24	165	3.7	
-135-M 67				135	67		190		
-140-M 42				140	42		195	3.9	
-165-M 67				165	67		220	4.0	
-M 97					97			3.8	
-170-M 42	2			170	42		225	4.3	
-195-M 67				195	67		250		
t=2.5 -M 97	1				97			4.0	
-M127					127			3.9	
-225-M 97	2			225	97		280	4.4	
-M127	1				127			4.0	
-M157					157				
-255-M127	2			255	127		310	4.7	▲
-M157	1				157			4.3	
-285-M157	2			285			340	4.9	
-SLRB 8- 90-M 22	1	8	18	90	22	24	145	3.7	×
-110-M 42				110	42		165		○
-120-M 22				120	22		175	3.9	×
-135-M 67				135	67		190	3.8	○
t=5 -140-M 42				140	42		195	4.0	
-150-M 22	2			150	22		205	4.3	×
-165-M 67	1			165	67		220	4.0	○
-170-M 42	2			170	42		225	4.5	
-195-M 67				195	67		250	4.4	
-SLFB8- 90-M 22	1	8	18	90	22	24	145	3.7	×
-110-M 42				110	42		165		○
-120-M 22				120	22		175	3.8	×
-135-M 67				135	67		190		○
t=5 -140-M 42				140	42		195	3.9	
-150-M 22	2			150	22		205	4.3	×
-165-M 67	1			165	67		220	4.0	○
-170-M 42	2			170	42		225	4.5	
-195-M 67				195	67		250	4.4	
-SLSA10-110-M 42	1	10	13	110	42	30	165	3.6	○
-135-M 67				135	67		190	3.7	
-140-M 42				140	42		195	3.9	
-165-M 67				165	67		220	4.0	
-M 97					97			3.8	
t=1.5 -170-M 42	2			170	42		225	4.0	
-195-M 67				195	67		250	4.5	
-M 97	1				97			3.9	
-225-M 97	2			225			280	4.6	▲
-SLSB10-110-M 42	1	10	16	110	42	30	165	3.7	○
-135-M 67				135	67		190	3.8	
-140-M 42				140	42		195	3.9	
-165-M 67				165	67		220		
-M 97					97				
-170-M 42	2			170	42		225	4.5	
-195-M 67				195	67		250	4.3	
-M 97	1				97			4.0	
t=3 -M127					127				
-225-M 97	2			225	97		280	4.4	▲
-M127	1				127			4.2	
-M157					157			4.1	
-255-M127	2			255	127		310	4.8	
-M157	1				157			4.4	
-285-M157	2			285			340	5.0	

CODE	Fig.	φD	φC	L	M	H	h	Kg	
BT50-SLRB10- 90-M 22	1	10	22	90	22	30	145	3.7	×
-110-M 42				110	42		165	3.8	○
-120-M 22				120	22		175	3.9	×
-135-M 67				135	67		190		○
t=6 -140-M 42				140	42		195		
-150-M 22	2			150	22		205	4.3	×
-165-M 67	1			165	67		220	4.1	○
-170-M 42	2			170	42		225	4.5	
-195-M 67				195	67		250	4.7	
-SLFB10- 90-M 22	1	10	22	90	22	30	145	3.7	×
-110-M 42				110	42		165		○
-120-M 22				120	22		175	3.9	×
t=6 -135-M 67				135	67		190	3.8	○
-140-M 42				140	42		195	4.0	
-150-M 22	2			150	22		205	4.3	×
-165-M 67	1			165	67		220	4.1	○
-170-M 42	2			170	42		225	4.5	
-195-M 67				195	67		250	4.6	
-SLSA12-110-M 42	1	12	15	110	42	30	165	3.7	○
-135-M 67				135	67		190		
-140-M 42				140	42		195	3.9	
-165-M 67				165	67		220		
-M 97					97				
-170-M 42	2			170	42		225	4.3	
-195-M 67				195	67		250	4.5	
-M 97	1				97			4.2	
-225-M 97	2			225			280	4.7	▲
-SLSB12-110-M 42	1	12	19	110	42	30	165	3.7	○
-135-M 67				135	67		190	3.8	
-140-M 42				140	42		195	4.0	
t=3.5 -165-M 67				165	67		220	3.9	
-M 97					97				
-170-M 42	2			170	42		225	4.5	
-195-M 67				195	67		250		
-M 97	1				97			4.2	
-M127					127			4.1	
-225-M 97	2			225	97		280	4.8	▲
-M127	1				127			4.3	
-M157					157				
-255-M127	2			255	127		310	4.9	
-M157	1				157			4.5	
-285-M157	2			285			340	5.1	
-SLRB12- 90-M 22	1	12	26	90	22	30	145	3.7	×
-110-M 42				110	42		165	3.8	
-120-M 22				120	22		175	4.0	
-135-M 67				135	67		190		
-140-M 42				140	42		195	4.1	
t=7 -150-M 22	2			150	22		205	4.6	
-165-M 67	1			165	67		220	4.2	
-170-M 42	2			170	42		225	4.7	
-195-M 67				195	67		250	4.8	
-SLFB12- 90-M 22	1	12	26	90	22	30	145	3.7	
-110-M 42				110	42		165	3.8	
-120-M 22				120	22		175	4.0	
-135-M 67				135	67		190	3.9	
-140-M 42				140	42		195	4.1	
t=7 -150-M 22	2			150	22		205	4.6	
-165-M 67	1			165	67		220	4.2	
-170-M 42	2			170	42		225	4.7	
-195-M 67				195	67		250	4.8	

CODE	Fig.	φD	φC	L	M	H	h	Kg
BT50-SLSB16-110-M 42	1	16	24	110	42	32	165	3.8
-135-M 67				135	67		190	3.9
-140-M 42				140	42		195	4.1
-165-M 67				165	67		220	
-M 97					97			4.0
-170-M 42	2			170	42		225	4.6
t=4 -195-M 67	1			195	67		250	4.5
-M 97					97			4.3
-M127					127			4.2
-225-M 97	2			225	97		280	4.9
-M127	1				127			4.6
-M157					157			4.4
-255-M127	2			255	127		310	5.5
-M157	1				157			4.8
-285-M157	2			285			340	5.7
-SLRB16- 90-M 22	1	16	32	90	22	32	145	3.8
-110-M 42				110	42		165	3.9
-120-M 22				120	22		175	4.1
-135-M 67				135	67		190	
t=8 -140-M 42				140	42		195	4.2
-150-M 22	2			150	22		205	4.6
-165-M 67	1			165	67		220	4.3
-170-M 42	2			170	42		225	4.8
-195-M 67				195	67		250	4.9
-SLFB16- 90-M 22	1	16	32	90	22	32	145	3.8
-110-M 42				110	42		165	3.9
-120-M 22				120	22		175	4.0
-135-M 67				135	67		190	4.1
t=8 -140-M 42				140	42		195	4.2
-150-M 22	2			150	22		205	4.6
-165-M 67	1			165	67		220	4.3
-170-M 42	2			170	42		225	4.5
-195-M 67	2			195	67		250	4.9
-SLSB20-110-M 42	1	20	29	110	42	40	165	3.8
-135-M 67				135	67		190	3.9
-140-M 42				140	42		195	4.1
-165-M 67				165	67		220	4.2
-M 97					97			4.1
-170-M 42	2			170	42		225	4.7
-195-M 67				195	67		250	4.8
t=4.5 -M 97	1				97			4.5
-M127					127			4.3
-225-M 97	2			225	97		280	5.4
-M127	1				127			4.7
-M157					157			4.6
-255-M127	2			255	127		310	5.6
-M157	1				157			5.0
-285-M157	2			285			340	5.9
-SLRB20-110-M 42	1	20	38	110	42	40	165	4.0
-135-M 67				135	67		190	4.2
t=9 -140-M 42				140	42		195	4.3
-165-M 67				165	67		220	4.6
-170-M 42	2			170	42		225	5.3
-195-M 67				195	67		250	5.5
-SLFB20-110-M 42	1	20	38	110	42	40	165	4.0
-135-M 67				135	67		190	4.2
-140-M 42				140	42		195	4.4
t=9 -165-M 67				165	67		220	4.5
-170-M 42	2			170	42		225	5.3
-195-M 67	1			195	67		250	4.8
-SLRB25-110-M 42	1	25	45	110	42	45	165	4.1
t=10 -140-M 42				140			195	4.5
-170-M 42	2			170				5.3
-SLFB25-110-M 42	1	25	45	110	42	45	165	4.0
t=10 -140-M 42				140			195	4.5
-170-M 42	2			170				5.4



A63-SLRB12-95-M42

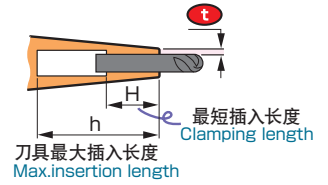

Fig. 1

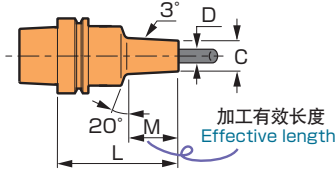
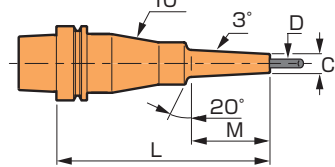

Fig. 2



- 标准附属品 Standard accessories
- 冷却液导管 Coolant duct

HEATROBO 电磁式
加热器对应表

○: 可加热 ×: 不可加热
▲: 请将刀柄直接放在定位板上 →P.15

Available holder list for
heat robo

○: Available ×: Not available
▲: Set up the holder on the
positioning plate directly. →P.15

CODE	Fig.	φD	φC	L	M	H	h	Kg
A63-SLSA 3- 95-M 42	1	3	6	95	42	9	70	0.7
-120-M 67				120	67		95	0.8
-125-M 42				125	42		100	0.9
-150-M 67				150	67		125	
-M 97					97			0.8
t=1.5 -155-M 42	2			155	42		130	1.2
-180-M 67				180	67		155	
-M 97	1				97			0.9
-210-M 97	2			210			185	1.2
-SLRA 3- 75-M 22	1	3	7.5	75	22	9	50	0.7
- 95-M 42				95	42		70	0.8
-105-M 22				105	22		80	0.9
-120-M 67				120	67		95	0.8
-125-M 42				125	42		100	0.9
HSK -135-M 22	2			135	22		110	1.1
-150-M 67	1			150	67		125	0.9
-M 97					97			0.8
t=2.25 -155-M 42	2			155	42		130	1.2
-180-M 67				180	67		155	
-M 97	1				97			0.9
-M127					127			1.0
-210-M 97	2			210	97		185	1.2
-M127	1				127			
-240-M127	2			240			215	1.7
-SLFB 3- 75-M 22	1	3	9.5	75	22	9	50	0.7
- 95-M 42				95	42		70	0.8
-105-M 22				105	22		80	0.9
-120-M 67				120	67		95	0.8
-125-M 42				125	42		100	0.9
t=3.25 -135-M 22	2			135	22		110	1.2
-150-M 67	1			150	67		125	0.9
-155-M 42	2			155	42		130	1.2
-180-M 67				180	67		155	
-SLSA 4- 95-M 42	1	4	7	95	42	12	70	0.8
-120-M 67				120	67		95	
-125-M 42				125	42		100	0.9
t=1.5 -150-M 67				150	67		125	
-M 97					97			0.8
-155-M 42	2			155	42		130	1.2
-180-M 67				180	67		155	
-M 97	1				97			0.9
-210-M 97	2			210			185	1.2

CODE	Fig.	φD	φC	L	M	H	h	Kg	
A63-SLRA 4- 75-M 22	1	4	10	75	22	12	50	0.7	○
- 95-M 42				95	42		70	0.8	
-105-M 22				105	22		80	0.9	
-120-M 67				120	67		95	0.8	
-125-M 42				125	42		100	0.9	
-135-M 22	2			135	22		110	1.2	
-150-M 67	1			150	67		125	0.9	
-M 97					97				
-155-M 42	2			155	42		130	1.2	
-180-M 67				180	67		155		
-M 97	1				97			1.0	
-M127					127				
-210-M 97	2			210	97		185	1.3	○
-M127	1				127			1.2	
-240-M127	2			240			215	1.7	
-SLFB 4- 75-M 22	1	4	12	75	22	12	50	0.8	
- 95-M 42				95	42		70		
-105-M 22				105	22		80	0.9	
-120-M 67				120	67		95	0.8	
-125-M 42				125	42		100	0.9	
-135-M 22	2			135	22		110	1.2	
-150-M 67	1			150	67		125	0.9	
-155-M 42	2			155	42		130	1.2	
-180-M 67				180	67		155		
-SLSA 6- 95-M 42	1	6	9	95	42	18	70	0.8	○
-120-M 67				120	67		95		
-125-M 42				125	42		100	0.9	
-150-M 67				150	67		125		
-M 97					97				
-155-M 42	2			155	42		130	1.2	
-180-M 67				180	67		155		
-M 97	1				97			1.1	
-210-M 97	2			210			185	1.6	
-SLSB 6- 95-M 42	1	6	10	95	42	18	70	0.8	
-120-M 67				120	67		95		
-125-M 42				125	42		100	0.9	
-150-M 67				150	67		125		
-M 97					97				
-155-M 42	2			155	42		130	1.2	
-180-M 67				180	67		155		
-M 97	1				97			1.1	
-M127					127			1.0	
-210-M 97	2			210	97		185	1.6	
-M127	1				127			1.2	
-M157					157			1.1	
-240-M127	2			240	127		215	1.7	
-M157	1				157			1.3	
-270-M157	2			270			245	1.8	▲
-SLRB 6- 75-M 22	1	6	14	75	22	18	50	0.8	○
- 95-M 42				95	42		70	0.9	
-105-M 22				105	22		80	1.0	
-120-M 67				120	67		95	0.9	
-125-M 42				125	42		100	1.1	
-135-M 22	2			135	22		110	1.6	
-150-M 67	1			150	67		125	1.1	
-155-M 42	2			155	42		130	1.6	
-180-M 67				180	67		155		
-SLFB 6- 75-M 22	1	6	14	75	22	18	50	0.8	
- 95-M 42				95	42		70	0.9	
-105-M 22				105	22		80	1.0	
-120-M 67				120	67		95	0.9	
-125-M 42				125	42		100	1.1	
-135-M 22	2			135	22		110	1.6	
-150-M 67	1			150	67		125	1.1	
-155-M 42	2			155	42		130	1.6	
-180-M 67				180	67		155		

CODE	Fig.	φD	φC	L	M	H	h	Kg	
A63-SLSA 8- 95-M 42	1	8	11	95	42	24	70	0.8	○
-120-M 67				120	67		95	0.9	
-125-M 42				125	42		100	1.0	
-150-M 67				150	67		125	1.1	
-M 97					97			0.9	
-155-M 42	2			155	42		130	1.5	
-180-M 67	2			180	67		155	1.6	
-M 97	1				97			1.1	
-210-M 97	2			210			185	1.6	
-SLSB 8- 95-M 42	1	8	13	95	42	24	70	0.8	
-120-M 67				120	67		95	0.9	
-125-M 42				125	42		100	1.1	
-150-M 67				150	67		125		
-M 97					97			1.0	
-155-M 42	2			155	42		130	1.6	
-180-M 67				180	67		155		
-M 97	1				97			1.2	
-180-M127					127			1.1	
-210-M 97	2			210	97		185	1.7	
-M127	1				127			1.3	
-M157					157			1.2	
-240-M127	2			240	127		215	1.8	▲
-M157	1				157			1.4	
-270-M157	2			270			245	1.9	
-SLRB 8- 75-M 22	1	8	18	75	22	24	50	0.9	X
- 95-M 42				95	42		70		○
-105-M 22				105	22		80	1.1	X
-120-M 67				120	67		95	1.0	○
-125-M 42				125	42		100	1.1	
-135-M 22	2			135	22		110	1.6	X
-150-M 67	1			150	67		125	1.2	○
-155-M 42	2			155	42		130	1.6	
-180-M 67				180	67		155	1.7	
-SLFB 8- 75-M 22	1	8	18	75	22	24	50	0.9	X
- 95-M 42				95	42		70		○
-105-M 22				105	22		80	1.1	X
-120-M 67				120	67		95	1.0	○
-125-M 42				125	42		100	1.1	
-135-M 22	2			135	22		110	1.6	X
-150-M 67	1			150	67		125	1.2	○
-155-M 42	2			155	42		130	1.6	
-180-M 67				180	67		155	1.7	
-SLSA10- 95-M 42	1	10	13	95	42	30	68	0.8	○
-120-M 67				120	67		93	0.9	
-125-M 42				125	42		98	1.0	
-150-M 67				150	67		123	1.1	
-M 97					97			1.0	
-155-M 42	2			155	42		128	1.6	
-180-M 67				180	67		153		
-M 97	1				97			1.2	
-210-M 97	2			210			183	1.7	
-SLSB10- 95-M 42	1	10	16	95	42	30	68	0.9	○
-120-M 67				120	67		93		
-125-M 42				125	42		98	1.1	
-150-M 67				150	67		123		
-M 97					97			1.0	
-155-M 42	2			155	42		128	1.6	
-180-M 67				180	67		153		
-M 97	1				97			1.2	
-M127					127			1.3	
-210-M 97	2			210	97		180	1.7	
-M127	1				127			1.6	
-M157					157			1.4	
-240-M127				240	127		215	2.0	▲
-M157					157			1.8	
-270-M157				270			245	2.1	

CODE	Fig.	φD	φC	L	M	H	h	Kg	
A63-SLRB10- 75-M 22	1	10	22	75	22	30	48	0.9	x
- 95-M 42				95	42		68		○
-105-M 22				105	22		78	1.1	x
-120-M 67				120	67		93	1.0	○
t=6 -125-M 42				125	42		98	1.2	
-135-M 22	2			135	22		108	1.6	x
-150-M 67	1			150	67		123	1.3	○
-155-M 42	2			155	42		128	1.7	
-180-M 67				180	67		153	1.8	
-SLFB10- 75-M 22	1	10	22	75	22	30	48	0.9	x
- 95-M 42				95	42		68		○
-105-M 22				105	22		78	1.1	x
t=6 -120-M 67				120	67		93	1.0	○
-125-M 42				125	42		98	1.2	
-135-M 22	2			135	22		108	1.6	x
-150-M 67	1			150	67		123	1.3	○
-155-M 42	2			155	42		128	1.7	
-180-M 67				180	67		153	1.8	
-SLSA12- 95-M 42	1	12	15	95	42	30	68	0.8	○
t=1.5 -120-M 67				120	67		93	0.9	
-125-M 42				125	42		98	1.0	
-150-M 67				150	67		123	1.1	
-M 97					97				
-155-M 42	2			155	42		128	1.6	
-180-M 67				180	67		153		
-M 97	1				97			1.3	
-210-M 97	2			210			183	1.8	▲
-SLSB12- 95-M 42	1	12	19	95	42	30	68	0.9	○
-120-M 67				120	67		93	1.0	
-125-M 42				125	42		98	1.1	
t=3.5 -150-M 67				150	67		123	1.2	
-M 97					97				
-155-M 42	2			155	42		128	1.6	
-180-M 67				180	67		153	1.7	
-M 97	1				97		150	1.6	
-M127					127		153	1.4	
-210-M 97				210	97		180	1.9	▲
-M127					127			1.7	
-M157					157		183	1.6	
-240-M127				240	127		215	2.1	
-M157					157			1.9	
-270-M157				270			245	2.2	
-SLRB12- 75-M 22	1	12	26	75	22	30	48	1.0	x
- 95-M 42				95	42		68	1.1	
-105-M 22				105	22		75	1.4	
-120-M 67				120	67		93	1.2	
t=7 -125-M 42				125	42		95	1.5	
-135-M 22				135	22		105	1.7	
-150-M 67				150	67		120		
-155-M 42				155	42		125	1.8	
-180-M 67				180	67		150	1.9	
-SLFB12- 75-M 22	1	12	26	75	22	30	48	1.0	x
- 95-M 42				95	42		68	1.1	
-105-M 22				105	22		75	1.4	
-120-M 67				120	67		93	1.2	
t=7 -125-M 42				125	42		95	1.5	
-135-M 22				135	22		105	1.7	
-150-M 67				150	67		120	1.6	
-155-M 42				155	42		125	1.8	
-180-M 67				180	67		150	1.9	

CODE	Fig.	φD	φC	L	M	H	h	Kg	
A63-SLSB16- 95-M 42	1	16	24	95	42	32	68	1.1	
-120-M 67				120	67		93	1.2	
-125-M 42				125	42		95	1.4	
-150-M 67				150	67		120	1.5	
-M 97					97		123	1.3	
-155-M 42				155	42		130	1.7	
t=4 -180-M 67				180	67		155	1.8	
-M 97					97			1.6	
-M127					127		153	1.5	
-210-M 97				210	97		185	2.0	
-M127					127			1.8	
-M157					157		183	1.7	
-240-M127				240	127		215	2.2	
-M157					157			2.1	
-270-M157				270			245	2.4	
-SLRB16- 75-M 22	1	16	32	75	22	32	48	1.1	
- 95-M 42				95	42		68	1.2	
-105-M 22				105	22		75	1.4	
-120-M 67				120	67		93		
t=8 -125-M 42				125	42		95	1.6	
-135-M 22				135	22		105	1.7	
-150-M 67				150	67		120		
-155-M 42				155	42		125	1.9	
-180-M 67				180	67		150	2.1	
-SLFB16- 75-M 22	1	16	32	75	22	32	48	1.1	
- 95-M 42				95	42		68	1.2	
-105-M 22				105	22		75	1.4	
-120-M 67				120	67		93		
t=8 -125-M 42				125	42		95	1.6	
-135-M 22				135	22		105	1.7	
-150-M 67				150	67		120		
-155-M 42				155	42		125	1.9	
-180-M 67				180	67		150	2.1	
-SLSB20- 95-M 42	1	20	29	95	42	40	68	1.1	
-120-M 67				120	67		93	1.2	
-125-M 42				125	42		95	1.4	
-150-M 67				150	67		120	1.6	
-M 97					97		123	1.4	
-155-M 42				155	42		130	1.8	
-180-M 67				180	67		155	1.9	
t=4.5 -M 97					97			1.7	
-M127					127		153	1.6	
-210-M 97				210	97		185	2.1	
-M127					127			2.0	
-M157					157		183	1.9	
-240-M127				240	127		215	2.3	
-M157					157			2.2	
-270-M157				270			245	2.6	
-SLRB20- 95-M 42	1	20	38	95	42	40	68	1.3	
-120-M 67				120	67		93	1.5	
-125-M 42				125	42		95	1.6	
t=9 -150-M 67				150	67		120	1.9	
-155-M 42				155	42		125	2.0	
-180-M 67				180	67		150	2.2	
-SLFB20- 95-M 42	1	20	38	95	42	40	68	1.3	
-120-M 67				120	67		93	1.5	
-125-M 42				125	42		95	1.6	
t=9 -150-M 67				150	67		120	1.9	
-155-M 42				155	42		125	2.0	
-180-M 67				180	67		150	2.2	
-SLRB25- 95-M 42	1	25	45	95	42	45	68	1.4	
t=10 -125-M 42				125			95	1.7	
-155-M 42				155			125	2.0	
-SLFB25- 95-M 42	1	25	45	95	42	45	68	1.4	
t=10 -125-M 42				125			95	1.7	
-155-M 42				155			125	2.0	

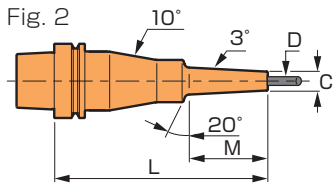
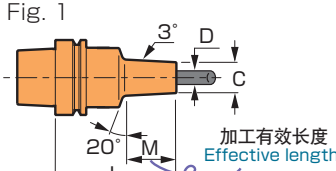
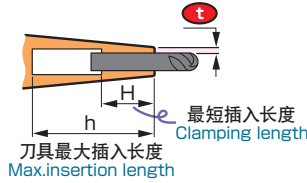

HEATROBO电磁式加热器对应表
 ○: 可加热 ×: 不可加热
 ▲: 请将刀柄直接放在定位板上 →P.15

Available holder list for heat robo
 ○: Available ×: Not available
 ▲: Set up the holder on the positioning plate directly. →P.15

CODE	Fig.	φD	φC	L	M	H	h	Kg	
A100-SLSA 3-110-M 42	1	3	6	110	42	9	80	2.2	○
-135-M 67				135	67		105	2.3	
-140-M 42				140	42		110		
-165-M 67				165	67		135		
-M 97					97				
-170-M 42	2			170	42		140	2.6	
t=1.5 -195-M 67				195	67		165		
-M 97	1				97			2.4	
-225-M 97	2			225	97		195	2.7	
-SLRA 3- 90-M 22	1	3	7.5	90	22	9	60	2.2	
-110-M 42				110	42		80		
-120-M 22				120	22		90		
-135-M 67				135	67		105	2.3	
-140-M 42				140	42		110		
HSK -150-M 22	2			150	22		120	2.6	
-165-M 67	1			165	67		135	2.4	
-M 97					97			2.3	
t=2.25 -170-M 42	2			170	42		140	2.6	
-195-M 67				195	67		165		
-M 97	1				97			2.4	
-M127					127				
-225-M 97	2			225	97		195	2.7	
-M127	1				127			2.6	
-255-M127	2			255			225	3.2	
-SLFB 3- 90-M 22	1	3	9.5	90	22	9	60	2.2	
-110-M 42				110	42		80	2.3	
-120-M 22				120	22		90		
-135-M 67				135	67		105		
-140-M 42				140	42		110	2.2	
t=3.25 -150-M 22	2			150	22		120	2.6	
-165-M 67	1			165	67		135	2.4	
-170-M 42	2			170	42		140	2.6	
-195-M 67				195	67		165		
-SLSA 4-110-M 42	1	4	7	110	42	12	80	2.3	○
-135-M 67				135	67		105		
-140-M 42				140	42		110	2.2	
-165-M 67				165	67		135	2.4	
-M 97					97			2.3	
t=1.5 -170-M 42	2			170	42		140	2.6	
-195-M 67				195	67		165		
-M 97	1				97			2.3	
-225-M 97	2			225			195	2.6	

CODE	Fig.	φD	φC	L	M	H	h	Kg	
A100-SLRA 4- 90-M 22	1	4	10	90	22	12	60	2.2	○
-110-M 42				110	42		80	2.3	
-120-M 22				120	22		90		
-135-M 67				135	67		106	2.2	
-140-M 42				140	42		110	2.3	
-150-M 22	2			150	22		120	2.6	
-165-M 67	1			165	67		135	2.4	
t=3 -M 97					97				
-170-M 42	2			170	42		140	2.6	
-195-M 67				195	67		165		
-M 97	1				97			2.4	
-M127					127				
-225-M 97	2			225	97		195	2.7	
-M127	1				127				
-255-M127	2			255			225	3.3	
-SLFB 4- 90-M 22	1	4	12	90	22	12	60	2.2	
-110-M 42				110	42		80	2.3	
-120-M 22				120	22		90	2.2	
-135-M 67				135	67		105	2.3	
-140-M 42				140	42		110	2.4	
t=4 -150-M 22	2			150	22		120	2.6	
-165-M 67	1			165	67		135	2.4	
-170-M 42	2			170	42		140	2.6	
-195-M 67				195	67		165	2.7	
-M 97	1				97				
-225-M 97	2			225	97		195	2.7	
-SLSA 6-110-M 42	1	6	9	110	42	18	80	2.1	○
-135-M 67				135	67		105	2.2	
-140-M 42				140	42		110		
HSK -165-M 67				165	67		135	2.3	
-M 97					97			2.4	
t=1.5 -170-M 42	2			170	42		140	2.6	
-195-M 67				195	67		165		
-M 97	1				97				
-225-M 97	2			225	97		195	2.9	
-SLSB 6-110-M 42	1	6	10	110	42	18	80	2.2	
-135-M 67				135	67		105	2.3	
-140-M 42				140	42		110		
-165-M 67				165	67		135	2.4	
-M 97					97				
-170-M 42	2			170	42		140	2.6	
-195-M 67				195	67		165		
t=2 -M 97	1				97				
-M127					127			2.5	
-225-M 97	2			225	97		195	3.2	
-M127	1				127			2.5	
-M157					157				
-255-M127	2			255	127		225	3.2	▲
-M157	1				157			2.6	
-285-M157	2			285			255	3.1	
-SLRB 6- 90-M 22	1	6	14	90	22	18	60	2.2	○
-110-M 42				110	42		80	2.3	
-120-M 22				120	22		90	2.5	
-135-M 67				135	67		105	2.3	
-140-M 42				140	42		110	2.4	
t=4 -150-M 22	2			150	22		120	2.8	
-165-M 67	1			165	67		135	2.6	
-170-M 42	2			170	42		140	3.1	
-195-M 67				195	67		165	3.2	
-SLFB 6- 90-M 22	1	6	14	90	22	18	60	2.3	
-110-M 42				110	42		80		
-120-M 22				120	22		90	2.4	
-135-M 67				135	67		105		
t=4 -140-M 42				140	42		110		
-150-M 22	2			150	22		120	2.8	
-165-M 67	1			165	67		136	2.5	
-170-M 42	2			170	42		140	3.1	
-195-M 67				195	67		165	2.9	

CODE	Fig.	φD	φC	L	M	H	h	Kg	
A100-SLSA 8-110-M 42	1	8	11	110	42	24	80	2.3	○
-135-M 67				135	67		105		
-140-M 42				140	42		110	2.5	
-165-M 67				165	67		135		
t=1.5 -M 97					97			2.4	
-170-M 42	2			170	42		140	3.1	
-195-M 67				195	67		165		
-M 97	1				97			2.5	
-225-M 97	2			225			195	3.2	
-SLSB 8-110-M 42	1	8	13	110	42	24	80	2.3	
-135-M 67				135	67		105		
-140-M 42				140	42		110	2.4	
-165-M 67				165	67		135		
-M 97					97				
-170-M 42	2			170	42		140	3.1	
-195-M 67				195	67		165	2.9	
t=2.5 -M 97	1				97			2.5	
-M127					127				
-225-M 97	2			225	97		195	3.0	
-M127	1				127			2.7	
-M157					157				
-255-M127	2			255	127		225	3.1	▲
-M157	1				157			2.9	
-285-M157	2			285			255	3.6	
-SLRB 8- 90-M 22	1	8	18	90	22	24	60	2.2	x
-110-M 42				110	42		80	2.3	○
-120-M 22				120	22		90	2.4	x
-135-M 67				135	67		105		○
t=5 -140-M 42				140	42		110		
-150-M 22	2			150	22		120	2.9	x
-165-M 67	1			165	67		135	2.6	○
-170-M 42	2			170	42		140	3.1	
-195-M 67				195	67		165	3.2	
-SLFB 8- 90-M 22	1	8	18	90	22	24	60	2.3	x
-110-M 42				110	42		80		○
-120-M 22				120	22		90	2.4	x
-135-M 67				135	67		105		○
t=5 -140-M 42				140	42		110	2.6	
-150-M 22	2			150	22		120	2.9	x
-165-M 67	1			165	67		135	2.6	○
-170-M 42	2			170	42		140	3.1	
-195-M 67				195	67		165	3.2	
-SLSA10-110-M 42	1	10	13	110	42	30	80	2.2	○
-135-M 67				135	67		105	2.3	
-140-M 42				140	42		110	2.2	
-165-M 67				165	67		135	2.5	
t=1.5 -M 97					97			2.4	
-170-M 42	2			170	42		140	3.1	
-195-M 67				195	67		165		
-M 97	1				97			2.6	
-225-M 97	2			225			195	3.0	▲
-SLSB10-110-M 42	1	10	16	110	42	30	81	2.3	○
-135-M 67				135	67		105	2.4	
-140-M 42				140	42		110		
-165-M 67				165	67		135	2.5	
-M 97					97				
-170-M 42	2			170	42		140	3.1	
-195-M 67				195	67		165	3.2	
-M 97	1				97			2.7	
-M127					127			2.6	
-225-M 97	2			225	97		195	3.0	▲
-M127	1				127			2.9	
-M157					157			2.8	
-255-M127				255	127		225	3.5	
-M157					157			3.0	
-285-M157				285			255	3.6	

CODE	Fig.	φD	φC	L	M	H	h	Kg	
A100-SLRB10- 90-M 22	1	10	22	90	22	30	60	2.3	x
-110-M 42				110	42		80	2.4	○
-120-M 22				120	22		90	2.5	x
-135-M 67				135	67		105		○
t=6 -140-M 42				140	42		110		
-150-M 22	2			150	22		120	3.1	x
-165-M 67	1			165	67		135	2.7	○
-170-M 42	2			170	42		140	3.2	
-195-M 67				195	67		165	3.3	
-SLFB10- 90-M 22	1	10	22	90	22	30	60	2.3	x
-110-M 42				110	42		80	2.4	○
-120-M 22				120	22		90		x
-135-M 67				135	67		105	2.5	○
t=6 -140-M 42				140	42		110	2.6	
-150-M 22	2			150	22		120	2.9	x
-165-M 67	1			165	67		135	2.7	○
-170-M 42	2			170	42		140	3.2	
-195-M 67				195	67		165	3.3	
-SLSA12-110-M 42	1	12	15	110	42	30	79	2.2	○
-135-M 67				135	67		104	2.3	
-140-M 42				140	42		105	2.4	
-165-M 67				165	67		130		
t=1.5 -M 97					97		134	2.5	
-170-M 42	2			170	42		135	3.1	
-195-M 67				195	67		160	2.9	
-M 97	1				97			2.7	
-225-M 97	2			225			190	3.3	▲
-SLSB12-110-M 42	1	12	19	110	42	30	79	2.3	○
-135-M 67				135	67		104		
-140-M 42				140	42		105	2.4	
-165-M 67				165	67		130	2.6	
-M 97					97			2.7	
-170-M 42	2			170	42		135	3.1	
-195-M 67				195	67		164	3.0	
t=3.5 -M 97	1				97		160	3.1	
-M127					127			2.9	
-225-M 97				225	97		190	3.4	▲
-M127					127			3.0	
-M157					157			3.1	
-255-M127				255	127		220	3.6	
-M157					157			3.1	
-285-M157				285			250	3.7	
-SLRB12- 90-M 22	1	12	26	90	22	30	55	2.6	x
-110-M 42				110	42		75	2.5	
-120-M 22				120	22		85	2.6	
-135-M 67				135	67		100	2.7	
-140-M 42				140	42		107		
t=7 -150-M 22				150	22		115	3.2	
-165-M 67				165	67		130	2.9	
-170-M 42				170	42		135	3.3	
-195-M 67				195	67		160	3.4	
-SLFB12- 90-M 22	1	12	26	90	22	30	55	2.4	
-110-M 42				110	42		75	2.7	
-120-M 22				120	22		85	2.6	
-135-M 67				135	67		100	2.7	
-140-M 42				140	42		105	3.0	
t=7 -150-M 22	2			150	22		115	3.3	
-165-M 67	1			165	67		130	2.9	
-170-M 42				170	42		135	3.3	
-195-M 67	2			195	67		162	3.5	

CODE	Fig.	φD	φC	L	M	H	h	Kg
A100-SLSB16-110-M 42	1	16	24	110	42	32	75	2.6
-135-M 67				135	67		100	2.7
-140-M 42				140	42		105	2.9
-165-M 67				165	67		130	2.8
-M 97					97			
-170-M 42				170	42		135	3.2
-195-M 67				195	67		160	3.3
t=4 -M 97					97			2.9
-M127					127			3.0
-225-M 97				225	97		190	3.5
-M127					127			3.4
-M157					157			3.3
-255-M127	2			255	127		220	4.3
-M157	1				157			3.7
-285-M157	2			285			250	4.6
-SLRB16- 90-M 22	1	16	32	90	22	32	55	2.4
-110-M 42				110	42		75	2.5
-120-M 22				120	22		85	2.7
-135-M 67				135	67		100	2.9
t=8 -140-M 42				140	42		107	2.8
-150-M 22				150	22		115	3.2
-165-M 67				165	67		130	3.0
-170-M 42				170	42		135	3.4
-195-M 67				195	67		160	3.6
-SLFB16- 90-M 22	1	16	32	90	22	32	55	2.4
-110-M 42				110	42		75	2.7
-120-M 22				120	22		85	
-135-M 67				135	67		100	2.9
t=8 -140-M 42				140	42		105	3.1
-150-M 22	2			150	22		115	3.4
-165-M 67	1			165	67		130	3.0
-170-M 42				170	42		135	3.4
-195-M 67				195	67		160	3.6
-SLSB20-110-M 42	1	20	29	110	42	40	75	2.6
-135-M 67				135	67		100	
-140-M 42				140	42		105	2.9
-165-M 67				165	67		130	3.1
-M 97					97			2.9
-170-M 42	2			170	42		135	3.4
-195-M 67	1			195	67		160	
t=4.5 -M 97					97			3.2
-M127					127			
-225-M 97				225	97		190	3.6
-M127					127			3.5
-M157					157			
-255-M127				255	127		220	3.8
-M157					157			3.7
-285-M157	2			285			250	4.8
-SLRB20-110-M 42	1	20	38	110	42	40	75	2.8
-135-M 67				135	67		100	3.1
t=9 -140-M 42				140	42		105	3.2
-165-M 67				165	67		130	3.5
-170-M 42				170	42		135	
-195-M 67	2			195	67		160	4.4
-SLFB20-110-M 42	1	20	38	110	42	40	75	2.8
-135-M 67				135	67		100	3.1
t=9 -140-M 42				140	42		105	
-165-M 67				165	67		130	3.5
-170-M 42				170	42		135	
-195-M 67				195	67		160	3.7
-SLRB25-110-M 42	1	25	45	110	42	45	75	2.9
t=10 -140-M 42				140			105	3.2
-170-M 42	2			170			135	4.2
-SLFB25-110-M 42	1	25	45	110	42	45	75	2.9
t=10 -140-M 42				140			105	3.2
-170-M 42	2			170			135	4.2

敝司也生产制作DIN锥柄、CAT锥柄。
 详情请向敝司垂询。
 We also deal with DIN and CAT shanks.
 Please contact us.

关于刀柄的安装固定 (HEATROBO电磁式加热器1200)
How to set up the holder (HEAT ROBO DENJI 1200)

一些型号的热装式刀柄无法使用 HEATROBO电磁式加热器进行加热，请确认所使用刀柄是否能在该加热器上使用。另外，表格中有「▲」处，请采用下列方法进行对应。

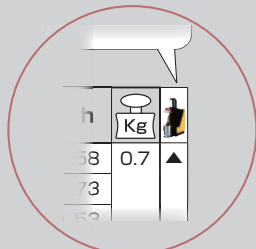

Some SLIMLINE holders cannot be heated due to its longer length than HRD-01. Confirm whether the holder is available or not. Please follow the operation below for the items marked ▲ in the list.

BT 锥柄

BT shank
 由于刀柄较长，不能直接进行加热。请拆卸下底板，在加热器底部垫上厚物。

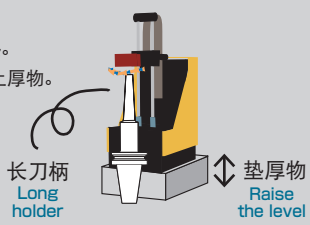

HSK 锥柄

HSK shank
 由于刀柄较长，不能直接进行加热。请将刀柄直接放置在定位底板上。

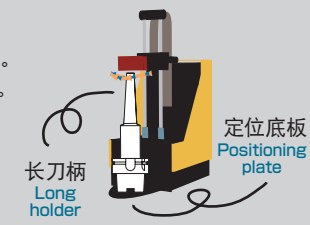

热装装置 HEAT ROBO

电磁感应式加热器

INDUCTION HEATER

DENJI HEAT ROBO 电磁 5000S

φ3~25
(φ1/8"~1")

三相
Three phase
200~240v
5kW

18 秒
sec.
φ6(1/4")

气体冷却
Air cooling time
1 分钟
min.

30kg
(67lbs)



加热线圈(选购品)
Heating Coil (Option)

适配器(选购品)
Adapter (Option)

底座(选购品)
Base (Option)

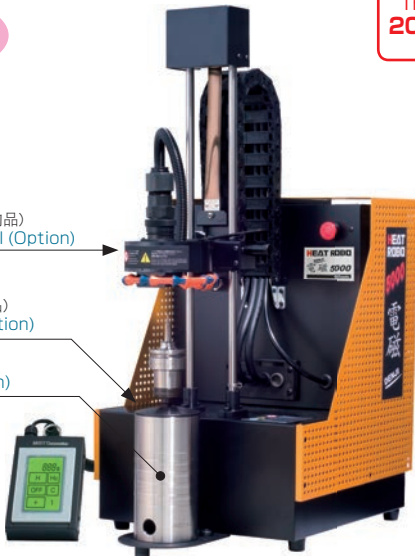

DENJI HEAT ROBO 电磁 1200S

φ3~12
(φ1/8"~1/2")

单相
Single phase
100v~120v~230v
1.2kW

18 秒
sec.
φ6(1/4")

气体冷却
Air cooling time
1 分钟
min.

19kg
(42lbs)



加热线圈(标准附属品)
Heating Coil (Option)

适配器(选购品)
Adapter (Option)

底座(选购品)
Base (Option)



变压器(230AS专用附属品)
Transformer

CODE	尺寸 Size (W×D×H)
HRD-02S	370×510×740 (14.60"×20.10"×29.20")

- 选购品 • 加热线圈 • 适配器 • 底座 • 刀具防脱片(HSB·HSC)
- 标准附属品 • 耐热手套 • 装卸用镊子 • 加热圈保护套
- 注意事项 • 需要自备变压器
- Option • Heating Coil • Adapter • Base • Cutter Stopper(HSB·HSC)
- Standard accessories • Heat-resistant gloves • Tweezers • Protection sheet for heating coil
- Caution • Transformer is required.

加热线圈(选购品)

Heating coil (Option)

	CODE	刀具直径 Cutter dia.	加热时间 Heating time
线圈 Coil 1	HRD2-CL1-01	φ 3~ 6 (1/8"~1/4")	18 秒 sec.
线圈 Coil 2	-CL2-01	φ 7~12 (5/16"~1/2")	28 秒 sec.
线圈 Coil 3	-CL3-01	φ 16, 20 (5/8", 3/4")	28 秒 sec.
线圈 Coil 4	-CL4-01	φ25 (1")	40 秒 sec.
线圈 Coil 5	-CL5-01	※	28 秒 sec.

- 标准附属品 • 加热圈保护套
- 备注※ • 对应刀柄为φ8, 10, 12, 16的有效长为M22的SLRB / SLFB型
- Standard accessories • Protection sheet for heating coil
- Note※ • Coil 5(※) is for dia. 8, 10, 12, 16 (5/16", 3/8", 1/2", 5/8") internal bore with M22 effective length holders, and for all of SLRB and SLFB type.

CODE	尺寸 Size (W×D×H)
HRD-01S-120NA * -230AS *	270×560×550 (10.70"×22.10"×21.70")

- 选购品 • 适配器 • 底座 • 刀具防脱片(HSB·HSC)
- 标准附属品 • 加热线圈 • 耐热手套 • 装卸用镊子 • 加热圈保护套
- 备注 • NA=北美洲用, AS=亚洲专用, 部分刀柄无法使用, 请参照编码表。
- Option • Adapter • Base • Cutter Stopper(HSB·HSC)
- Standard accessories • Heating Coil • Heat-resistant gloves • Tweezers • Protection sheet for heating coil
- Note • NA=For North America, AS=For Asia.

加热线圈(标准附属品)

Heating coil

	CODE	刀具直径 Cutter dia.	加热时间 Heating time
线圈 Coil 1	HRD-CL1-01	φ3~ 6 (φ1/8"~1/4")	18 秒 sec.
线圈 Coil 2	-CL2-01	φ7~12 (φ5/16"~1/2")	33 秒 sec.

- 标准附属品 • 加热圈保护套
- Standard accessories • Protection sheet for heating coil

热装附件

2 体型系列 2 PIECE-modular	适配器 Adapter	底座 Base	加热装置 Shrink-fit heater				
			HRB-03S	HRB-02S	HRB-01	HRD-02S	HRD-01S
热装式筒夹 SLIMLINE COLLET (CS,CR,CF)	ADH-SLK	BAA-01	○	○	○	○	○

一体型系列 MONO series	适配器 Adapter	底座 Base	加热装置 Shrink-fit heater				
			HRB-03S	HRB-02S	HRB-01	HRD-02S	HRD-01S
A63	ADH-40	BAA-01	○	△ ※	×	○	△ ※
BT50 A100	ADH-50		○	△ ※	×	○	△ ※

可热装的刀柄外径尺寸
Effective shrink-fit dimension
C=φ32
※C=φ24(M22)

部分刀柄无法使用
请参照编码表
There are some limitations.
Check the code table.

热风式加热器

HOT AIR HEATER

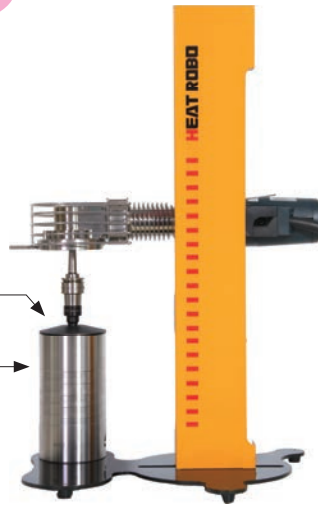
HEAT ROBO Baby3000S**HEAT ROBO Baby1200S**200V・230V
3kWφ3~25
(φ1/8"~1")70^{sec.}
φ6(1/4")
CE
(230EU)气体冷却
Air cooling time
10^{分钟}9.5kg
(67lbs)φ3~12
(φ1/8"~1/2")100V・120V
1.2kW120^{sec.}
φ6(1/4")8kg
(18lbs)适配器(选购品)
Adapter(Optional)底座(选购品)
Base(Optional)

CODE	尺寸 Size (W×D×H)
HRB-03S-230NA*	450×215×570
-230EU*	(17.80"×8.50"×22.50")
-230AS*	

CODE	尺寸 Size (W×D×H)
HRB-02S-120NA*	360×105×570
	(14.20"×4.20"×22.50")

- 选购品
 - 标准附属品
 - 备考※
 - Option
 - Standard accessories
 - Note※
- 适配器
 - 底座
 - 刀具防脱片
 - 耐热手套
 - 装卸用镊子
 - 定时器
 - NA=北美州用, EU=欧洲用, AS=亚洲专用
 - Adapter
 - Base
 - Cutter Stopper
 - Heat-resistant gloves
 - Tweezers
 - Timer
 - NA=For North America, EU=For Europe, AS=For Asia.

- 选购品
 - 标准附属品
 - 备考※
 - Option
 - Standard accessories
 - Note※
- 适配器
 - 底座
 - 刀具防脱片
 - 耐热手套
 - 装卸用镊子
 - 定时器
 - NA=北美州用
 - Adapter
 - Base
 - Cutter Stopper
 - Heat-resistant gloves
 - Tweezers
 - Timer
 - NA=For North America

SETUP JIGS

直柄延长杆 STRAIGHT arbor		加热装置 Shrink-fit heater						
对应锥柄 Shank type	螺丝尺寸 Screw size	适配器 Adapter		HRB-03S	HRB-02S	HRB-01	HRD-02S	HRD-01S
ST10	M 6		ADH-SLK	○	△ ※	×	○	△ ※
ST12	M 8		BAS-01					
ST16/20/25	M10							
ST32	M16							
ST42	M24							
硬质合金柄 Carbide shank ST00C	—		BAS-02					

可热装的刀柄外径尺寸
Effective shrink-fit dimension
C=φ32
※
C=φ24(M22)

部分刀柄无法使用
请参照编码表
There are some limitations.
Check the code table.

HSA (弹簧圈型)

HSA (Coil spring type)

CODE	φD	数量 Q'ty
HSA-D	3, 3.175, 4, 5, 6, 7, 8, 9, 10, 11, 12 (1/8", 3/16", 1/4", 5/16", 3/8", 1/2")	同尺寸 10个 Contains 10 pcs. in each size
-F	3, 4, 5, 6, 7, 8, 9, 10, 11, 12 (1/8", 3/16", 1/4", 5/16", 3/8", 1/2")	各1个 计10个 10pcs. in total with each one
-EF	3, 4, 5, 6, 8, 10, 12, 16, 20, 25 (1/8", 3/16", 1/4", 5/16", 3/8", 1/2", 5/8", 3/4", 1")	立铣刀尺寸各1个 计10个 10pcs. in total with each one (in end-mill size increments)

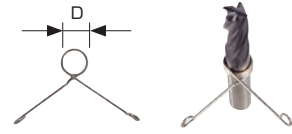

备注：无法在电磁加热器上使用。
Note: Cannot be used with Heat Robo Denji.

例如 Ex. HSA-3

HSB (弹簧片型)

HSB (Plate spring type)

CODE	φD
HSB-D	3, 3.175, 4, 5, 6, 7, 8, 9, 10, 11, 12, 16, 20, 25 (1/8", 3/16", 1/4", 5/16", 3/8", 1/2", 5/8", 3/4", 1")

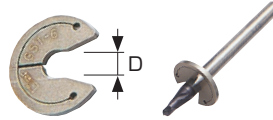

防脱片夹钳
Stopper pliers
(SPY-01)

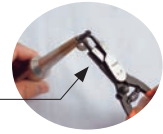

例如 Ex. HSB-6

HSC(槽孔筒夹型) HSC (Slit collet type)

CODE	φD
HSC-3	3
-3.175	3.175
-4	4
-6	6

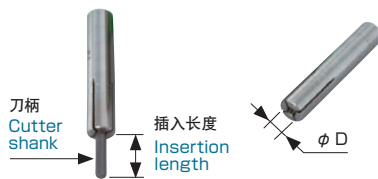

方便于小径阶梯型刀具
Convenient for roumer type tools
(non-inverse diameter tools)
with a small diameter.

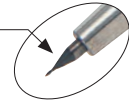

例如 Ex. HSC-4

其他

Miscellaneous (Useful optional accessories)

刀具夹钳 Cutter pliers

CODE
HPY-01



解除使用耐热手套时的烦扰!
Cutting tool plier eliminates
the hassle of using a
heat-resistant glove.

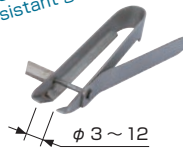

防脱片夹钳 Stopper pliers

CODE
SPY-01

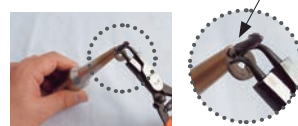

简单地安装HSB型刀具防脱片!
Stopper plier can easily attach
the HSB type removable
stopper.



筒夹台 Collet stand

CODE
SDK-01

Size: 190×190
(7.50"×7.50")

热装筒夹(12型)
直柄延长杆(ST16/20/25)专用台
Stand for SLIMLINE collets
(12 type), STRAIGHT
arbor(ST16/20/25)



刀具托盘 Cutter tray

CODE
SDH-01

Size: 170×170
(6.70"×6.70")

放置加热后取出的热刀具,
(冷却用)
Made of aluminum,
assuring superior cooling



刀具调整器

Cutter adjuster

CODE	φD	L
HAJ-3	3	10~30
-3.175	3.175	
-4	4	13~30
-6	6	19~45
-8	8	25~55
-10	10	31~70
-12	12	31~85
-16	16	33~90
-20	20	41~100
-25	25	46~100

可设置刀具突出长度。
同时,可以将多个刀具长度保持一致。
(防脱片HSB型, HSC型组合使用。)

Allows you to set the
overhang of a cutting
tool or align the lengths
of several cutting tools
(used in combination
with an HSB- or HSC-
type stopper)

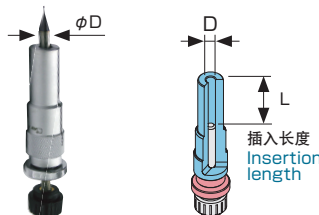

※不适合英制尺寸刀具
※Cannot handle non-metric (inch) tools.

新概念

价格、交期、重量都只有通常的一半。

NEW CONCEPT!

Price, delivery time, and weight are less than half that of conventional ones.

角度头加工的80%是钻孔加工和攻丝加工。所以，融合最低限度刚性和精度的最佳设计。诞生了最轻巧、袖珍的角度头。

Drilling and tapping account for 80% of angle head operation.

Therefore, optimal design is used to limit the rigidity and accuracy to the necessary levels.

As a result, the most lightweight and compact-body Angle Head was born.

简单固定于机床!

Easy installation for machines

安装简单,可立即使用。

可以原样利用现在使用的定位块。

Can be used immediately because set-up is so easy.

All kinds of existing positioning block are available without any modification.

90° type

A63-HFD12-183

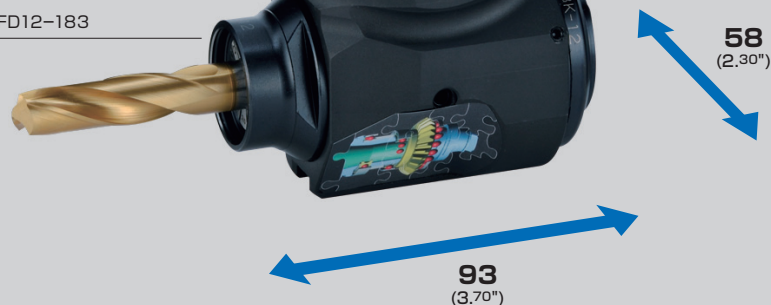

93
(3.70")

CODE (本体 Master holder)	Fig.	φD	L	M	Kg (lbs)		最高转速 Allowable spindle rotation (min-1) [主轴(逆转):角轴(正转)] [Main spindle(CCW): Angle shaft(CW)]
BT BT50-HFD12-135	1	2.5 ~ 13	135	70	6.3	D 12	4000 : 4000
			195	130	7.6		
			255	190	8.9		
-HFA20-150	2	5.8 ~ 20	150	77	7.1	C 20	6000 : 5000 (1 : 0.83)
			210	137	8.3		
			270	197	9.4		
-HFT 6-135	3	M3 ~ M12	135	70	6.3	TA 6	4000 : 4000
			195	130	7.6		
			255	190	8.9		
-HFT12-150	4	M3 ~ M16	150	77	7.1	TA 6 TA12	6000 : 5000 (1 : 0.83)
			210	137	8.3		
			270	197	9.4		
HSK A 63-HFD12-123	1	2.5 ~ 13	123	70	3.3	D 12	4000 : 4000
			183	130	4.7		
			243	190	6.0		
-HFA20-198	2	5.8 ~ 20	198	137	5.4	C 20	6000 : 5000 (1 : 0.83)
			258	197	6.5		
			-HFT 6-123	3	M3 ~ M12		
183	130	4.7					
243	190	6.0					
-HFT12-198	4	M3 ~ M16	198	137	5.4	TA 6 TA12	6000 : 5000 (1 : 0.83)
			258	197	6.5		
			DIN DN50A-HFD12-135	1	2.5 ~ 13		
195	130	7.1					
255	190	8.4					
-HFA20-150	2	5.8 ~ 20	150	77	6.6	C 20	6000 : 5000 (1 : 0.83)
			210	137	7.8		
			270	197	8.9		
-HFT 6-135	3	M3 ~ M12	135	70	5.8	TA 6	4000 : 4000
			195	130	7.1		
			255	190	8.4		
-HFT12-150	4	M3 ~ M16	150	77	6.6	TA12	6000 : 5000 (1 : 0.83)
			210	137	7.8		
			270	197	8.9		
CAT. CT50-HFD12-135	1	2.5 ~ 13 (.10 ~ .51")	135 (5.31")	70 (2.75")	5.8 (12.8)	D 12	4000 : 4000
			195 (7.68")	130 (5.11")	7.1 (15.6)		
			255 (10.04")	190 (7.47")	8.4 (18.5)		
-HFA20-150	2	5.8 ~ 20 (.23 ~ .79")	150 (5.91")	77 (3.03")	6.6 (14.7)	C 20	6000 : 5000 (1 : 0.83)
			210 (8.27")	137 (5.39")	7.8 (17.3)		
			270 (10.63")	197 (7.76")	8.9 (19.8)		
-HFT 6-135	3	M3 ~ M12 (#4 1/2)	135 (5.31")	70 (2.75")	5.8 (12.8)	TA 6	4000 : 4000
			195 (7.68")	137 (5.39")	7.1 (15.6)		
			255 (10.04")	190 (7.47")	8.4 (18.5)		
-HFT12-150	4	M3 ~ M16 (#4 5/8)	150 (5.91")	77 (3.03")	6.6 (14.7)	TA12	6000 : 5000 (1 : 0.83)
			210 (8.27")	137 (5.39")	7.8 (17.3)		
			270 (10.63")	197 (7.76")	8.9 (19.8)		

- 选购品
 - 标准附属品
 - 备考
 - 注意事项
 - Option
 - Standard accessories
 - Note
 - Caution
- DETa-1超弹性弹簧筒夹(HFD)→P.23
 - 冷却液导管(HSK-A)
 - 购买时, 请指定所需本体和固定座架、定位栓的型号。
 - 有因干涉而无法进行ATC换刀的可能。详情请向敝司垂询。
 - DETa-1 Collet(HFD)→P.23
 - The tool for assembly
 - Please specify the model no. of angle head and bracket set, when ordering.
 - ATC may not be possible in some cases because of interference. Please ask for details.
- 弹簧筒夹(HFA)→P.25
 - 六角扳手套装
 - 辅助扳手
 - 扳手(HFA20)
 - 丝锥筒夹(HFT)→P.21
 - 拉钉
 - 组装机用刃物
 - 弹簧筒夹(HFA)→P.25
 - 六角扳手套装
 - 辅助扳手
 - 扳手(HFA20)
 - Tap sleeve(HFT)→P. 21
 - Retention knob
 - Hexagonal wrench set
 - Spanner
 - Spanner for HFA20

钻孔加工
Drilling

Fig. 1

HFD12

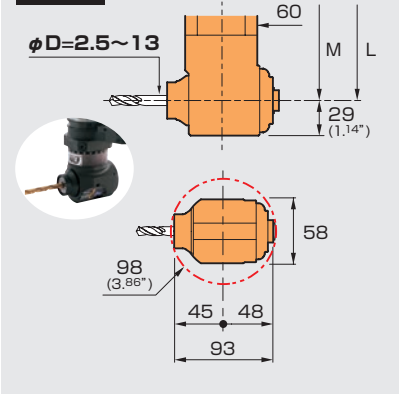

钻头加工·立铣刀加工
Drilling·Endmilling

Fig. 2

HFA20

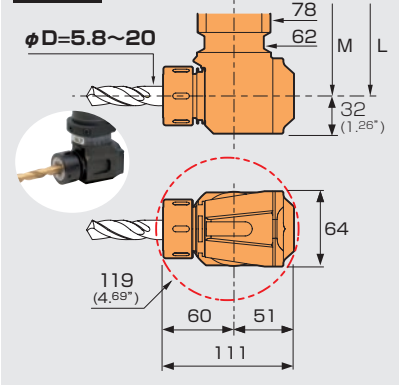

丝锥加工
Tapping

Fig. 3

HFT6

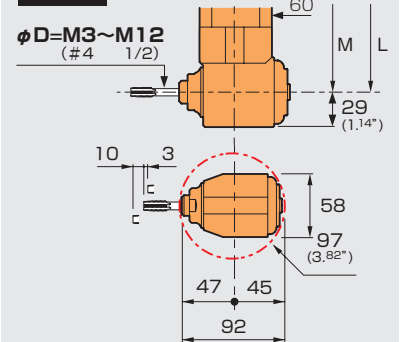
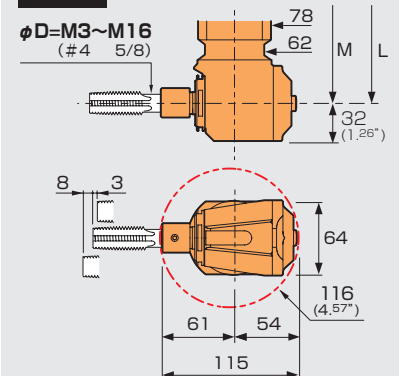

Fig. 4

HFT12



丝锥筒套

Tap sleeve

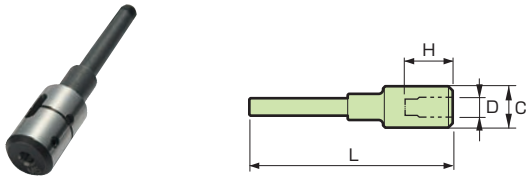

CODE	ϕD	L	ϕC	H	适应本体 Shank type
TA 6-M 3	M 3	92	19	21	HFT 6
-M 4	M 4			22	HFT 12
-M 5	M 5				
-M 6	M 6				
-M 8	M 8			23	
-M10	M10				
-M12	M12			24	
TA12-M14	M14	111.5	25	33	HFT12
-M16	M16			35	

*Available for ANSI, DIN and ISO tap sleeve upon request.

角度头 非标设计产品

ANGLE HEAD CUSTOM-MADE PRODUCTS

弊司有大量非标设计生产制作的实绩。可根据加工目不同设计最佳产品并进行生产，详情请向弊司垂询。

We have also designed and manufactured a large number of custom-made products.

The most suitable product will be designed and manufactured to meet your requirements.



双向角度头
Twin cut type

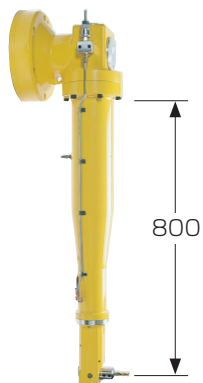

超长型二重轴角度头
Extra long type

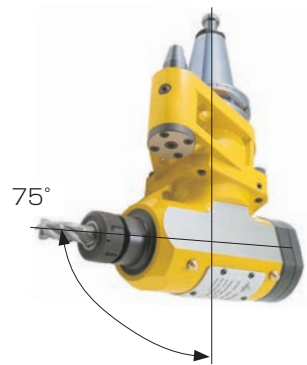

75度 角度头
75 degree angle



细长超薄型角度头
Slim and extended type

DETa-1 超弹性筒夹刀柄

DETa-1 COLLET HOLDER



DETa-1

DTA

操作简单
紧固螺母方式
Easy operation
Nut-tightening type



DTB

细长和高平衡特性
展现高性价比
For high-speed cutting
High cost performance



1 个筒夹夹持范围量可达
2 mm !!

2mm (.08")
collapsibility with just
one collet !!

伸缩范围
Collapsibility

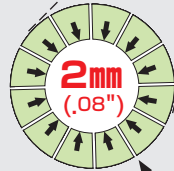

12 分割
高精度夹持
12 segments
Highly accurate chucking

DETa-1 超弹性筒夹刀柄 A型 (DTA)

DETa-1 COLLET HOLDER A type (DTA)

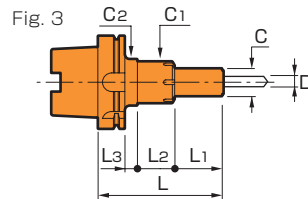
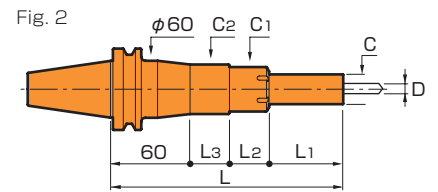
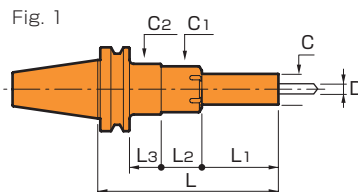

CODE	Fig.	φD	L	φC	L1	L2	L3	φC1	φC2	Kg (lbs)
BT	1	2.5~13	135	30	52.5	40	4.5	45	50	4.1
			165		75		12			4.3
			195		42		4.7			
			255		102		5.5			
			315		2		315			6.6
A	3	2.5~13	120	30	52.5	40	1.5	45	50	1.2
			150		75		9			1.4
			180		39		1.8			
A100	3	2.5~13	135	30	52.5	40	13.5	45	50	2.7
			165		75		21			2.9
			225		81		3.8			
DN50A	1	2.5~13	135	30	52.5	40	7.5	45	50	3.6
			165		75		15			3.8
			195		45		4.2			
CT50	1	2.5 ~ 13 (.10" ~ .51")	130	30 (1.18")	53 (2.08")	40 (1.57")	18.45 (.73")	45 (1.77")	69.85 (2.75")	3.5 (7.72)
			152 (5.98")		75 (2.95")		17.95 (.71")		3.6 (7.94)	
			203 (7.87")		53 (2.09")		50 (1.97")		4.2 (9.26)	

- 选购品
- 标准附属品
- DETA-1超弹性弹簧筒夹
- 冷却液导管(HSK-A)
- 扳手
- 拉钉
- Option
- Standard accessories
- DETA-1 Collet
- Coolant duct(HSK-A)
- Spanner
- Retention knob



BT50-DETB12-135

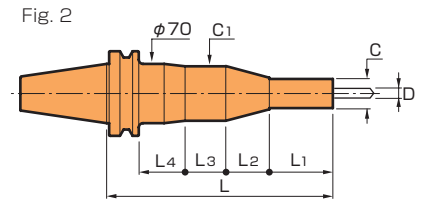
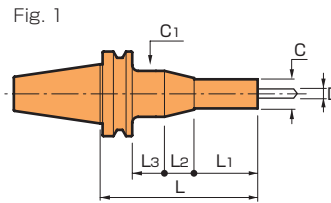

CODE	Fig.	φD	L	φC	L1	L2	L3	L4	φC1	Kg (lbs)
BT BT50-DETB12- 75 -105 -135 -195 -255 -315	1	2.5 ~ 13	75	30	37	—	—	—	—	3.7
			105		67	4.0				
			135		97					
			195		105	35.3	16.7	50	4.7	
			255			58.8	53.2			60
			315		2	315	—	50.2	63	7.5
DIN DN50AD-DETB12-135 -195	2	2.5 ~ 13	135	30	100	—	—	15.9	—	3.5
			195		105	35.3	19.7	50	4.2	
CAT. CT50-DETB12-135 -195	1	2.5 ~ 13 (.10" ~ .51")	135 (5.31")	30 (1.18")	100 (3.94")	—	16 (.63")	—	69.85 (2.75")	3.5 (7.72)
			195 (7.68")		105 (4.13")	35.3 (1.39")	19.7 (.78")	50 (1.97")	4.1 (9.04)	

- 选购品 ●DETa-1超弹性弹簧筒夹 ●扳手 ●拉钉
- Option ●DETa-1 Collet ●Wrench ●Retention knob

DETa-1 超弹性弹簧筒夹

DETa-1 collet

扳手

Wrench



CODE		φD	H2
标准级 Standard Collet	超精密级 Precision Collet		
D12- 4	请在标准级的 末尾处加“-P” Add “-P” after the standard type item code. < 例如 Ex. > D10-6-P	2.5 ~ 4 (.10" ~ (.16")	16
- 6		4 ~ 6 (.16" ~ (.24")	20
- 8		6 ~ 8 (.24" ~ (.31")	22
-10		8 ~ 10 (.31" ~ (.39")	
-12		10 ~ 12 (.39" ~ (.47")	
-13		11 ~ 13 (.43" ~ (.51")	

CODE	Fig.	刀柄类型 Holder type
F - 45	1	DTA12
TW - 6	2	DTB12



超弹性弹簧筒夹的偏摆精度
Run-out accuracy of DETa-1 collet

筒夹	D12
超精密级 (P级)	5 (10) μm
标准级	10 (15) μm

※括号 () 表示利用伸缩范围时筒夹单体的精度
※Accuracy of collet alone. () means collapsibility usable.

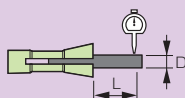

φD	L
~10	4×D
10~13	40

弹簧筒夹刀柄

COLLET HOLDER

筒夹刀柄 高速回转规格(CTH)

COLLET HOLDER For high-speed (CTH)



A63-CTH20-90

Fig. 1

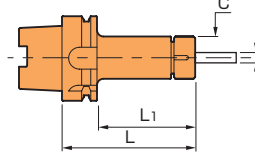
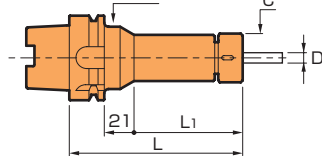

Fig. 2



CODE	Fig.	φD	L	φC	L1	Kg	
HSK A 63-CTH10- 75	1	2.4 ~ 10	75	36	49	0.9	
			90		64	1.0	
			120		94	1.2	
			150		124	1.4	
			-CTH20- 90		5.8 ~ 20	90	50
-120	120	94	1.5				
-150	150	124	1.9				
-CTH25-105	5.8 ~ 25	105	62	79		1.6	
A100-CTH10-135	1	2.4 ~ 10	135	36		106	
-165			165		136	2.9	
-225			225		175	3.4	
-CTH20-135	1	5.8 ~ 20	135	50	106	3.2	
-165			165		136	3.6	
-225			225		196	4.3	
-CTH25-135			5.8 ~ 25		135	62	106
-165	165	136		4.3			
-195	195	166		4.8			

- 选购品
 - 弹簧筒夹
 - 扳手
 - 可调整扭矩扳手
 - 冷却液贯穿系统
 - 间隙螺母
- 标准附属品
 - 圆形螺母 (NUA-CTH)
 - 冷却液导管
- 备注
 - 请务必使用P级 (超精密级) 弹簧筒夹
- Options
 - Spring collet
 - Spanner
 - Adjustable torque wrench
 - Coolant screw
 - Sukima nut
- Standard accessories
 - Nut (NUA-CTH)
 - Coolant duct
- Note
 - Collapsibility of collet cannot use.

筒夹刀柄 (CTA)

COLLET HOLDER (CTA)



BT50-CTA20-135

Fig. 1

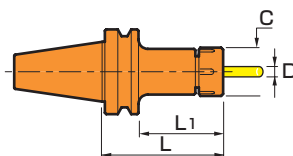
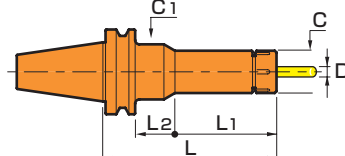

Fig. 2



CODE	Fig.	φD	L	φC	L1	L2	φC1	Kg (lbs)				
BT BT50-CTA10-165	1	2.4 ~ 10	165	36	127	—	—	4.0				
			195		157	—	—	4.2				
	2		255		155	62	55	4.9				
			315		122	—	—	5.8				
-CTA20-105	1	5.8 ~ 20	105	50	67	—	—	4.0				
			135		97	—	—	4.4				
			165		127	—	—	4.8				
			195		157	—	—	5.2				
	2		255		180	37	65	6.3				
			315		97	—	—	7.7				
			-CTA25- 75		1	5.8 ~ 25	75	62	37	—	—	3.6
							105		67	—	—	4.2
135	97	—		—			4.8					
165	127	—		—			5.4					
195	157	—		—			6.0					
255	217	—		—			7.2					
2	315	225		52			70		8.7			
	-CTA32- 90	1		24.8 ~ 32			90		74	52	—	—
120			82		—	—	4.7					
150			112		—	—	5.4					
180			142		—	—	6.1					
-CTA40- 90			1		31.8 ~ 42	90	90	52		—	—	4.0
						120		82		—	—	5.0

- 选购品
 - 弹簧筒夹
 - 扳手
 - 拉钉
 - 可调整扭矩扳手
- 标准附属品
 - 圆形螺母 (NUA-CTA)
- Options
 - Spring collet
 - Spanner
 - Retention knob
 - Adjustable torque wrench
- Standard accessories
 - Nut (NUA-CTH)

CODE	Fig.	φD	L	φC	L1	L2	φC1	
DIN DN50AD-CTA20-105 -165 -CTA25-105	2	5.8 ~ 20	105	50	70	-	-	2.3
			165		130			3.0
		5.8 ~ 25	105	62	70			2.9
CAT. CT50 -CTA20-105 -165 -CTA25-105	1	5.8 ~ 20 (.23" ~ .79")	105 (4.13")	50 (1.97")	70 (2.68")	-	-	3.6 (7.94)
			165 (6.50")		130 (5.12")			4.4 (9.70)
		5.8 ~ 25 (.23" ~ .98")	105 (4.13")	62 (2.44")	70 (2.68")			3.9 (8.60)

弹簧筒夹

Spring collet

	CODE		φD	刀柄型式 Holder type	伸缩范围 Collapsibility	L	φD1	H
	标准级 Standard Collet	超精密级 Precision Collet						
	C10-D	请在标准级的末尾处加“-P” Add “-P” after the standard type item code. < 例如 Ex. > C10-6-P	2.6 2.8 3 3.2 3.4 (0.2mm间隔 In 0.2mm steps) 9.4 9.6 9.8 10	CTA10 CTH10	0.2	26	17.2	D= 2.6~ 5 → 16 5.2~ 5.8 → 18 6 ~ 10 → 20
	C20-D		6 6.2 6.4 6.6 6.8 (0.2mm间隔 In 0.2mm steps) 19.4 19.6 19.8 20	CTA20 CTH20	0.2	50	29.5	D= 6 ~ 9.8 → 29 10 ~ 15.8 → 33 16 ~ 20 → 40
	C25-D		6 8 10 10.5 11 11.5 12 (0.5mm间隔 In 0.5mm steps) 23 23.5 24 24.5 25	CTA25 CTH25	0.2	68	36.5	D= 6 ~ 8 → 35 10 ~ 15 → 46 15.5~20 → 54 20.5~25 → 57
	C32-D		25 28 30 32	CTA32 CTH32	0.2	80	46	D=25 ~28 → 66 30 ~32 → 68
	C40-D		32 40 42	CTA40	0.2	80	56	D=32 ~40 → 65 42 → 70

	CODE		φD	Holder type	Collapsibility	L	φD1	H
	标准级 Standard collet	超精密级 Precision collet						
	C20-D		1/ 4 5/16 3/8	CTA20	0.2 (.008")	50 (1.97")	29.5 (1.16")	29 (1.14")
			7/16 1/ 2					33 (1.30")
			5/ 8 3/ 4					40 (1.57")
	C25-D		1/ 4 5/16 3/8	CTA25	0.2 (.008")	68 (2.67")	36.5 (1.44")	35 (1.38")
		7/16 1/ 2	46 (1.81")					
		5/ 8 3/ 4	54 (2.12")					
		1IN	57 (2.24")					

弹簧筒夹的摆动精度 Run-out accuracy of Spring collet

筒夹	摆动精度
超精密级 (P级)	5 μm
标准级	10 μm

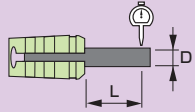

φD	L
~10	4×D
10 ~20	40
20.5~25	60

※筒夹单体的精度
※Accuracy of collet alone

扳手

Spanner

可调整扭矩扳手

Adjustable torque wrench

CODE	刀柄类型 Holder type	R	L	紧固扭矩 Tightening torque (kgf·m)
FC-36	CTA10, CTH10	18	208	4 ~ 6
-50	CTA20, CTH20	25	281	12
-62	CTA25, CTH25	31	312	15
-74	CTA32	37	364	
-90	CTA40	45		

可以更适宜地调节螺母的拧紧转矩
The nut-tightening torque can be adjusted more properly.

扭矩扳手头部 Spanner for torque wrench	可调整扭矩扳手 Adjustable torque wrench	对应刀柄类型 Holder type
FC-36AW	AW-1	CTA10, CTH10
-50AW	-2	CTA20, CTH20

SUMMIT 强力防振侧固式刀柄

SUMMIT



BT50-SLZ32-105

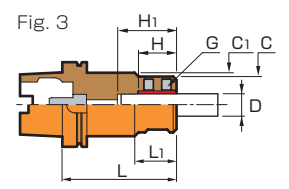
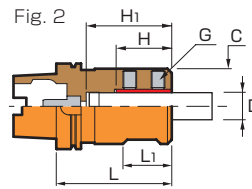
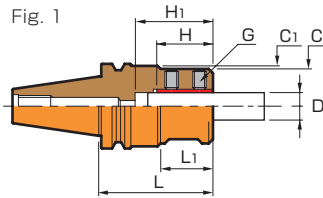

CODE	Fig.	φD	L	L1	φC	φC1	H	H1	G	Kg	
BT50-SLZ25-90	1	25	90	—	66	—	45	70	4-M12	4.6	
-120			120	45		75				5.6	
-150			150	—		—				6.5	
-SLZ32-105		32	105	—	88	—	65	100		6-M16	5.9
-135			135	62		95					7.5
-165			165	—		—					9.1
-SLZ42-105	42	105	—	98	—	70	110	—	6.1		
-135		135	—		—				7.8		
-165		165	—		—				9.5		
A100-SLZ25-135	2	25	135	66	66	75	45		70	4-M12	4.9
-SLZ32-135	3	32	135	88	88	—	65		100	6-M16	6.1
-SLZ42-135		42		98	98	70	—		—	—	6.6

- 选购品
 - 扳手 ●调整螺丝(BT)
 - 喷嘴 (HSK) ●拉钉
- 标准附属品
 - 冷却液导管(HSK-A)
- 注意事项
 - 不使用专用拧紧扳手时,请用柄长30cm(M16)以上,20cm(M12)以上的扳手紧固。
- Option
 - Wrench ●Adjust screw(BT)
 - Nozzle(HSK) ●Retention knob
- Standard accessories
 - Coolant duct(HSK-A)
- Caution
 - If the dedicated wrench is not used, use a wrench with a minimum handle length of 30 cm for the M16 or 20 cm for the M12.

扳手

Wrench

喷嘴

Nozzle

调整螺丝

Adjust screw

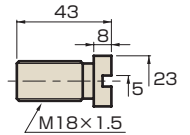
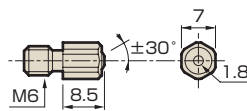
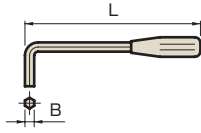

CODE	B	L	刀柄类型 Holder type	紧固扭矩 Tightening torque (kgf·m)
W-206	6	200	SLZ25	4
-308	8	300	SLZ32 SLZ42	10

CODE	数量 Q'ty
NOZ-M6-12	12
-60	60

- 标准附属品 ●专用扳手
- Standard accessories ●Wrench for attachment

可调节刀具长度
The overhang of the cutting tool can be adjusted.

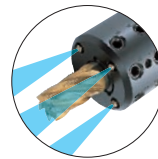

CODE	刀柄类型 Shank type
AJC-M18L	BT50

HI-ART 强力铣刀柄

Hi-ART MILLING CHUCK



BT50-ART32-105



A100-ART32-135

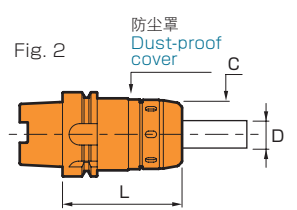
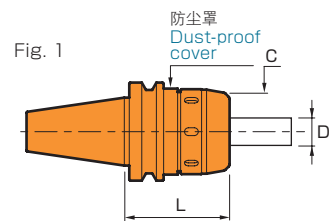

CODE	Fig.	φD	L	φC	刀具的夹持长度 Cutter Insertion length	Kg	最高转速 min-1 Allowable spindle rotation, min-1.			
BT50-ART32-105	1	32	105	82	66 ~ 98	5.1	5,000			
-135			135							
-165			165							
-180			180							
-ART42-105			42					105	97	76 ~ 108
-135	135									
A 63-ART32-100	2	32		100	72	2.0	6,000			
A 100-ART32-135			135	82				66 ~ 98	5.3	5,000
-ART42-135			42							

- 选购品
 - 直筒夹(→P. 28) ●带推顶勾的扳手
 - 喷嘴 ●调整螺丝 ●拉钉
- 标准附属品
 - 冷却液导管(HSK-A)
- 備考
 - 利用冷却液贯穿【喷嘴贯穿】时,需要开孔拉钉和喷嘴
- Options
 - Straight collet(→P. 28) ●Nozzle
 - Spanner with ejection hook
 - Retention knob ●Adjust screw
- Standard accessories
 - Coolant duct(HSK-A)
- Note
 - To utilize the coolant-through nozzle capability, the retention knob with hole and nozzle are required.

带推顶勾的扳手 Spanner with ejection hook

不仅可以安装刀具,也可以取出直筒夹。
This spanner can be used to both tighten a nut and remove a straight collet.

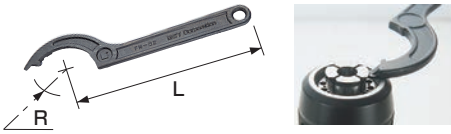

CODE	R	L	刀柄类型 Holder type	紧固扭矩 Tightening torque
FM-72	36	204	ART32 (A63)	6kgf·m
-82	41	234	ART32 (BT50, A100)	7kgf·m
-97	48.5	239	ART42	

调整螺丝 Adjust screw

可以自由调整刀具的突出长度。
The overhang of the cutting tool can be adjusted.

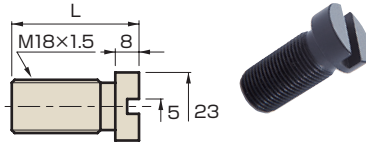

CODE	L	刀柄类型 Holder type
AJN-M18L	38	A 63
-M18	63	BT50, A100

喷嘴 Nozzle

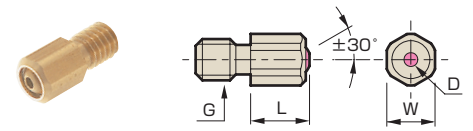

CODE	L	G	W	phi D	刀柄类型 Holder type
NOZ-M6	8.5	M6	7	1.8	BT50

■标准附属品 ■Standard accessories ●专用扳手 ●Wrench for attachment

直筒夹 Straight collet

标准型
Standard type



喷嘴用切槽
Notch for nozzle

F型
F type

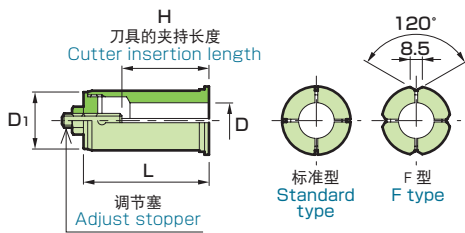

CODE		phi D	刀柄型式 Holder type	L	phi D1	H
标准型 Standard type	F型 F type					
S32- 6	S32- 6F	6	ART32	75	32	30~68
- 8	- 8F	8				40~68
-10	-10F	10				50~68
-12	-12F	12				
-16	-16F	16				
-20	-20F	20	ART42	80	42	35~73
-25	-25F	25				45~73
S42- 6	S42- 6F	6				
- 8	- 8F	8				
-10	-10F	10				55~73
-12	-12F	12				
-16	-16F	16				
-20	-20F	20				
-25	-25F	25				
-32	-32F	32				

※A63-ART32-100 使用直柄筒夹时, 请取出调节塞

※Remove the adjust stopper when using a straight collet with A63-ART32-100.

FACE MILL ARBOR 面铣用刀柄

FACE MILL ARBOR









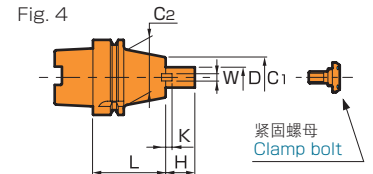
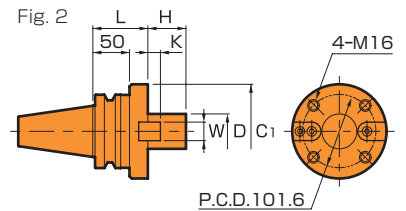
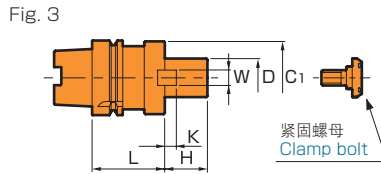
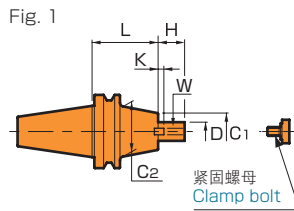

BT50-FMA38.1-45



A63-FMA25.4-90



CODE	Fig.	刀径 Cutter dia	phi D(h6)	L	phi C1	phi C2	H	W	K	Kg	紧固螺母 Clamp bolt	
BT BT50-FMC22 - 90	1	50,63,80	22	90	45	-	18	10	5	4.3	M10 x 35L	
				150								
		-FMA25.4 - 45	76	25.4	45	50	70	22	9.5	7	4.6	MBA - M12
					90							
					150							
					150							
-FMA31.75 - 45	102	31.75	45	60	-	30	12.7	7	4.6	MBA - M16		
			75									
			105									
			105									
BT50-FMA38.1 - 45	1	127	38.1	45	80	-	34	15.9	9	4.3	MBA - M20	
				75								
		-FMA50.8 - 45	152,178	50.8	45	100	-	36	19	10	4.8	MBA - M24
					75							
-FMA47.625 - 75	2	203	47.625		128.57		38	25.2	12.5	7.6	M16(4个) 4pcs) ※	

CODE	Fig.	刀径 Cutter dia	φD(h6)	L	φC1	φC2	H	W	K		紧固螺母 Clamp bolt	
A 63 -FMC22 - 60	3	50, 63, 80	22	60	45	-	18	10	5		MBP - M10C	
				90								
		-FMA25.4 - 60	76	25.4	60	50	-	22	9.5	7		MBC - M12
					90							
-FMA31.75 - 60	3	102	31.75	60	60	-	30	12.7	7		MBC - M16	
				90								
A100 -FMC22 -105	3	50, 63, 80	22	105	45	-	18	10	5		MBP - M10C	
				150								
				195								
-FMA25.4 -105	4	76	25.4	105	50	75	22	9.5	5		MBC - M12	
				135								
				195								
				195								
-FMA31.75 -105	3	102	31.75	105	60	-	30	12.7	7		MBC - M16	
				127								
-FMA38.1 - 90		127	38.1	90	80	-	34	15.9	9		MBC - M20	
-FMA50.8 - 75		152, 178	50.8	75	100	-	36	19	10		MBC - M24	

HSK

- 选购品
- 标准附属品
- 备考
- 扳手 ● 拉钉
- 紧固螺母 ● 冷却液导管(HSK-A) ● 止动键
- 使用中心通冷时, 需配备以下零件。(HSK) 1.冷却液导管 2.紧固螺母(MBP, MBC)
- 因刀具厂商和型号不同, 紧固螺母也不相同。因此, 部分产品无附带紧固螺母。
- Options
- Standard accessories
- Note
- Spanner ● Retention knob
- Clamp bolt ● Coolant duct(HSK-A) ● Drive key
- The following parts are required when using the coolant-through model (HSK). 1.Coolant duct(HSK-A) 2.Clamp bolt(MBP, MBC)
- Clamp bolt varies depending on the manufacturer and model of the cutter. The provided clamp bolts might be unusable.

刀具紧固台 TOOL SET UP STAND

MY CUBE 50 / 100

MY CUBE 50 / 100

CODE	刀柄型式 Holder type	
MY CUBE 50	BT50/DIN50/CAT50	9.7
MY CUBE 100	HSK-A100, T100	9.6

- 选购品
- 标准附属品
- 注意事项
- Options
- Standard accessories
- Caution
- 适配器 (MY CUBE 50)
- 标示牌
- 没有附带安装螺栓。安装时请使用 2 个 M12 螺栓。
- Adapter (MY CUBE 50)
- Name plate
- No mounting bolts are provided. Use two M8 bolts for mounting.

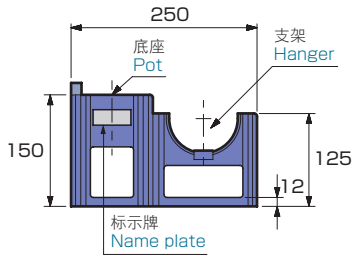

标示牌 Name plate



附带特制精加工的金属铭牌, 可雕刻贵公司名称。
可以雕刻英文(大写), 数字及一(短横线)共12字。
A specially finished name plate is provided, on which your company name is inscribed.
Up to 12 characters (upper-case alphabetic characters, numeric characters, and/or hyphens).

适配器 Adapter

适配器 (纵向用) Adapter for pot

CODE	刀柄型式 Holder type
AP50-A63V	HSK -A63, T63

适配器 (横向用) Adapter for hanger

CODE	刀柄型式 Holder type
AP50-A63H	HSK -A63, T63



HF系列

HF series

CODE	Fig.	刀柄型式 Holder type	
HF - BT50	1	BT50/DIN50/CAT50	2.2
- A 63	2	HSK-A63, T63	1.2
- A100	1	HSK-A100, T100	2.1

