

Shrink-fit Heater **HEAT ROBO**

Long holder life

Shrink-fitting temperature is comparatively low, about 300°C [570°F], which is safer for the holders.
Affordable and compact design for simple shrink fitting.

Induction Heater

HEAT ROBO 電磁 DENJI

- Rapid shrink-fitting
- Compact A4 size~
- Easy operation with touch panel!



Hot-air Heater

HEAT ROBO Baby

- Compact Affordable
- No risk of overheating



	DENJI 電磁 5000S	DENJI 電磁 2500	DENJI 電磁 1200S	Baby 3000S	Baby 1200S	Baby 1000
CODE	HRD-02SH	HRD-03	HRD-01S	HRB-03S	HRB-02S	HRB-01
Heating method	Induction type			Hot air type		
Rated power consumption	5000w	2500w	1200w	3000w	1200w	1000w
Rated voltage	3 phases 200~240v	Single phase 200~240v	100v	Single phase 200v	100v	
Cutter dia.	φ3~32 [1/8"~1]	φ3~16 [1/8"~5/8]	φ3~12 [1/8"~1/2]	φ3~32 [1/8"~1]	φ3~12 [1/8"~1/2]	
Heating time (dia.φ6)	18 sec. (Auto setting)	25 sec.	18 sec.	70 sec.	120 sec.	180 sec.
Cooling method*	○ (1min.)			○ (5min.)	▲	
Size (WxDxH) mm	340×470×750		230×540×550	430×330×600	370×260×590	320×160×410

※About cooling method [○]: Air cooling using factory air. [▲]: Cooling operation using air cooling capability of a hot air heater.

Compatibility table by holder type

Holder Type	HRD-02SH	HRD-03	HRD-01S	HRB-03S	HRB-02S	HRB-01
MONO series	○	△	△	○	△	×
2 PIECE type	○	○	○	○	○	○
UNO	○	○	○	○	○	×
HYPER VERSION	○	×	×	○	×	×
STRAIGHT arbor	○	△	▲	▲	▲	×

[○]: Available [×]: Not available [△]: Refer to size chart [▲]: Requires recombinations of adapters and bases.

*Please verify compatibility for specific holders.

Feature

Shrink-fit Heater

MONO 3° MONO CURVE

MONO Series

2PIECE type

UNO

HYPER VERSION

STRAIGHT arbor

OTHERS

PERIPHERALS

Technical information

INDUCTION HEATER

DENJI 電磁 5000S

CODE	Size (W×D×H)	Rated voltage	Kg
HRD-02SH	340×470×750mm	3 phases 200-240v	30

Option

- Heating coil(HRD2-CL) •Coil stand
- Please choose parts on P.15-17

Std. Access.

- Heat-resistant gloves •Tweezers

Note

- Use type HSB/HSC for cutter stopper.
- Compressed air required: 0.5MPa (air-consumption volume: 245l/min)
- The customer should prepare the following items : auxiliary parts including the air tube (O.D. : 8mm.) an air filter and a coupler.

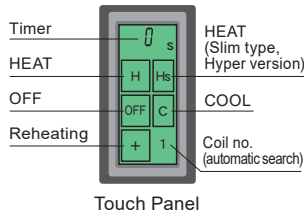

- Max. Cutter dia. **φ3~32 [1/8~1"]**
- Rated power consumption **5000w**
- Cutter dia. φ6
- Heating **18 sec.**
- Air-cooling **1 min.**

Heating coil (Option)

CODE	Heating coil No.	Holder I.D.	Heating time (Auto setting)	φC	H	Protection sheet for heating coil
HRD2-CL1	1	φ3~ 6 [1/ 8" ~ 1/4]	18 sec.	25	33	HRD2-DN1
-CL2	2	φ7~12※1 [5/16" ~ 1/2]	28 sec.	35	42	-DN2
-CL3	3	φ16, 20※2※3 [5/ 8", 3/4"]	28 sec.	45	47	-DN3
-CL4	4	φ25 [1"] MONO series •MONO 3°[A50M-SLRB20, F63-SLFB20]	40 sec.	55	57	-DN4
-CL5	5	MONO series •MONO 3°[SLRB-SLFB8/10/12/16-M22]	35 sec.	Fig.1		-DN5
-CL6	6	HYPER VERSION •Short type(All sizes) •Heavy-duty type [φ 12, 25]	40 sec.	60	47	-DN6
-CL7	7	φ32, HYPER VERSION •Heavy-duty type [φ20, 25]	60 sec.	70	67	-DN7

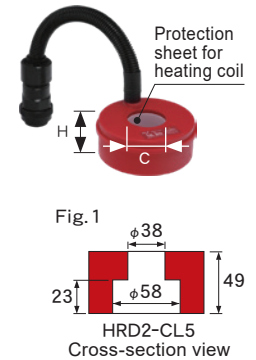

Std. Access.

- Protection sheet for heating coil

Note

- The coil protection sheet is a consumable part. Replace the coil protection sheet(option) when you see that it is colored or distorted by the heat.

Caution

- To protect the heating coil, don't heat a holder without using a coil protection sheet.
- When ordering, please note that holders for coil 5, 6, or 7 cannot be heated by 2, 3, or 4.
 - ※1 Use the coil, No.5 for SLRB-SLFB8/10/12-M22.
 - ※2 Use the coil, No.5 for SLRB-SLFB16-M22.
 - ※3 Use the coil, No.4 for A50M-SLRB20, E50-SLRA16-60-M22, E50-SLRA20-65-M22, F63-SLFB20

DENJI 電磁 2500

One Heating Coil supports dia.3-16mm of shrink-fit holder SLIMLINE. You can escape the inconvenience of changing heating coils.

CODE	AREA	Holder I.D.	Size (W×D×H)	Rated voltage	Kg
HRD-03-L	Japan, North America	φ3~16 [1/8" ~ 5/ 8]	340×470×750mm	Single-phase 200-240v	30
-S		φ3~ 8 [1/8" ~ 5/16]			
-LSE	Europe, Asia	φ3~16			
-SSE		φ3~ 8			

Option

- Please choose parts on P.15-17

Std. Access.

- Heat-resistant gloves •Tweezers
- Protection sheet for heating coil

Note

- Use type HSB/HSC for cutter stopper.
- Compressed air required: 0.5MPa (air-consumption volume: 245l/min)
- The customer should prepare the following items : auxiliary parts including the air tube (O.D. : 8mm.) an air filter and a coupler.

Caution

- The HEATROBO DENJI 2500 (HRD-03) is unable to shrink the HYPER version.

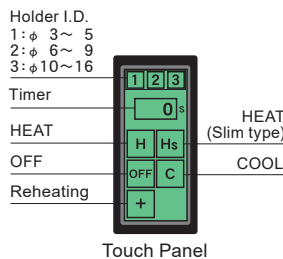

- Max. Cutter dia. **φ3~16 [1/8~5/8"]**
- Rated power consumption **2500w**
- Cutter dia. φ6
- Heating **25* sec.**
- Air-cooling **1 min.**

*HRD-03-S/SSE is designed for dia.3 to 8mm, you can shrink-in and out in a short time.

Protection sheet for heating coil

CODE	Shrink-fit Heater
HRD3-DN1	HRD-03-L / LSE
-DN2	-S / SSE

Note

- The coil protection sheet is a consumable part. Replace the coil protection sheet(option) when you see that it is colored or distorted by the heat.

DENJI 電磁1200S

CODE	AREA	Size (W×D×H)	Rated voltage	
HRD-01S	Japan	230×410×550mm	100v	14
-01S-120NA	North America	230×540×550mm	120v	19
-230AS	Asia		Single phase 230v	

Option

- Please choose parts on P.15-17

Std. Access.

- Heating coil(HRD-CL) •Heat-resistant gloves
- Tweezers

Note

- Use type HSB/HSC for cutter stopper.
- Compressed air required: 0.5MPa (air-consumption volume: 245l/min)
- The customer should prepare the following items : auxiliary parts including the air tube (O.D. : 8mm.) an air filter and a coupler.
- A transformer is required in Europe. Please consult MST about the details of the transformer.

Caution

- The HEATROBO DENJI 1200S (HRD-01S) is unable to shrink certain holders. For details, refer to P.233.

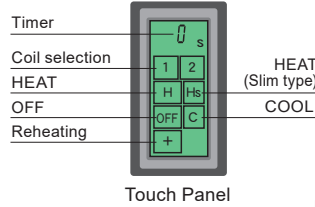

- Max. Cutter dia. **φ3~12 [1/8~1/2"]**
- Rated power consumption **1200w**
- Cutter dia. φ6
- Heating **18 sec.**
- Air-cooling **1 min.**

Heating coil

CODE	Heating Coil No.	Holder I.D.	Heating time	φC	Protection sheet for heating coil
HRD-CL1	1	φ3~ 6 [1/ 8" ~ 1/4]	18 sec.	18	HRD-DN1
-CL2	2	φ7~12 [5/16" ~ 1/2]	33 sec.	28	-DN2

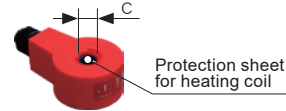

Std. Access.

- Protection sheet for heating coil

Caution

- To protect the heating coil, don't heat a holder without using a coil protection sheet.

Note

- The coil protection sheet is a consumable part. Replace the coil protection sheet(option) when you see that it is colored or distorted by the heat.

Coil stand

For the heating coil of HRD-02SH

CODE
CLSD01

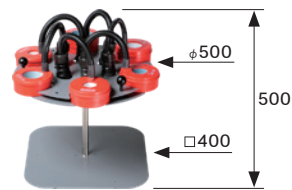

※Heating coils are not included.

Feature

Shrink-fit Heater

MONO 3°
MONO CURVE

MONO Series

2PIECE type

UNO

HYPER VERSION

STRAIGHT arbor

OTHERS

PERIPHERALS

Technical information

HOT AIR HEATER

Baby 3000S

CODE	Area	Size (W×D×H)	Rated voltage	kg
HRB-03S	Japan	430×330×600mm	Single phase 200 v	9.5
-03S-230NA	North America		Single phase 230 v	
-230EU	Europe			
-230AS	Asia			

Option

- φ70 Nozzle •Please choose parts on P.15-17.

Std. Access.

- Safety timer •Heat-resistant gloves •Tweezers

Note

- Compressed air required: 0.5MPa(air-consumption volume: 245 l/min)
- Prepare an air tube (O.D.: 8mm) and a connection coupling.

Shrink-fit heater with the safety timer.

Prevent accidents caused by leaving the heater on.

CODE	Area	Size (W×D×H)	Rated voltage	kg
HRB-03ST	Japan	430×330×600mm	Single phase 200 v	9.7
-03ST-230NA	North America		Single phase 230 v	
-230EU	Europe			
-230AS	Asia			

φ70 Nozzle

When heating the SLIMLINE MONO 3°, SLRB32, and the heavy-duty type Hyper Version, the 70mm dia. nozzle HRB-NZL70 is required.

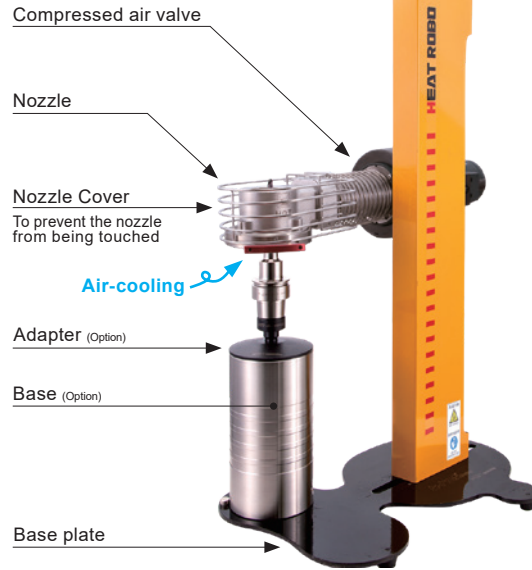

Max. Cutter dia.
φ3~32 [1/8~1"]

Rated power consumption
3000w

Cutter dia. φ6
Heating **70 sec.**

Air-cooling
5 min.

It's an eco-friendly heater, preventing overheating and conserving energy.

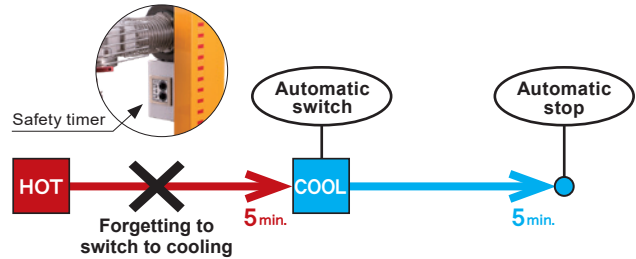

Even if you forget to switch to cooling operation, this unit automatically switches to the cooling operation 5 minutes after the heating operation started to prevent overheating problems.

Baby 1200S



Max. Cutter dia.
φ3~12 [1/8~1/2"]

Rated power consumption
1200w

Cutter dia. φ6
Heating **120 sec.**

CODE	Area	Size (W×D×H)	Rated voltage	kg
HRB-02S	Japan	370×260×590mm	100 v	8.0
-02S-120NA	North America		120 v	

Option

- Please choose parts on P.15-17.

Std. Access.

- Timer •Heat-resistant gloves •Tweezers

Note

- Some holders cannot be used.(P.15)

Baby 1000



Max. Cutter dia.
φ3~12 [1/8~1/2"]

Rated power consumption
1000w

Cutter dia. φ6
Heating **180 sec.**

CODE	Area	Size (W×D×H)	Rated voltage	kg
HRB-01	Japan	340×160×410mm	100 v	3.5

Option

- Please choose parts on P.15-17.

Std. Access.

- Adapter (ADH-SLK) •Timer •Nozzles, 2 pieces (HNZ-17, HNZ-22)
- Heat-resistant gloves •Tweezers

Note

- A transformer is required in other voltage. Please consult MST about the details of the transformer.

Option

■ Base

CODE
BAA-01

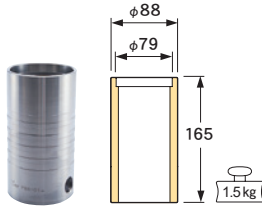

Examples of typical uses

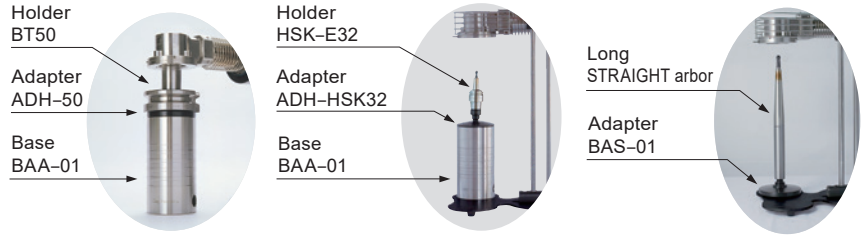

■ Adapter

CODE	Dimensions	Holder		Shrink-Fit Heater model for Use						
		Type	Screw size	HRD-02SH	HRD-03	HRD-01S	HRB-03S	HRB-02S	HRB-01	
ADH-SLK		2 PIECE type SLIMLINE collet	6 type	M6	○	○	○	○	○	○
			8 type	M6						
			12 type	M10						※Adapter (ADH-SLK) is included. No need to purchase base (BAA-01) for 2piece collet type 12.
			ST10	M6						
			ST12	M8						
		STRAIGHT arbor	ST16/20/25	M10						
ADH-HSK25		MONO 3° MONO CURVE UNO HYPER VERSION	E25		○	△	△	○	△	×
-HSK32			E32				※Some holders cannot be used. Please refer to the dimensional sheet.		※Some holders cannot be used.	
-HSK40E			E40							
-HSK40A			A40							
-HSK50			A50 / E50 / F63							
-40			BT40 / A63 F63 / F80 / F80PD DN40 / CT40							
-50			BT50 / A100 DN50 / CT50							
-15TR			15TR3							
-S20TR			RS20 / S20TR							
-BT30			BT30							
BAS-01		STRAIGHT arbor	ST16/20/25	M10	○	△	△	○	○	×
			ST32	M16						
			ST42	M24						
-02			Carbide Shank ST○○C							

[○]: Available

[×]: Not available

[△]: Restricted use

Cutter Stopper

Used as a stopper in the holder when shrink fitting or removing a cutting tool.

HSA_{type} (Coil Spring Type)

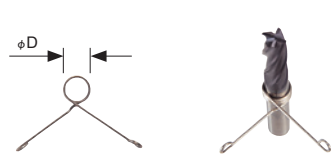

CODE	φD	Set Contents(Q'ty)
HSA-D [Ex : HSA-6]	3, 3.175 [1/8"], 4, 5, 6, 7, 8, 9, 10, 11, 12, 16, 20, 25, [3/16", 1/4", 5/16", 3/8", 1/2"]	Each size 10 ea. /SET
-E	3, 4, 6, 8, 10, 12	1 ea., 6 pieces in total
-F	3, 4, 5, 6, 7, 8, 9, 10, 11, 12	1 ea., 10 pieces in total
-EF	3, 4, 5, 6, 8, 10, 12, 16, 20, 25	1 ea., 10 pieces in total

HSB_{type} (Plate Spring Type)

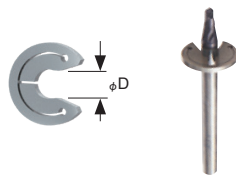

CODE	φD	Set Contents(Q'ty)
HSB-D [Ex : HSB-6]	3, 3.175 [1/8"], 4, 5, 6, 7, 8, 9, 10, 11, 12, 16, 20, 25, 32, [3/16", 1/4", 5/16", 3/8", 1/2", 5/8", 3/4", 1"]	1 ea.
-E	3, 4, 6, 8, 10, 12	1 ea., 6 pieces in total
-F	3, 4, 5, 6, 7, 8, 9, 10, 11, 12	1 ea., 10 pieces in total
-EF	3, 4, 5, 6, 8, 10, 12, 16, 20, 25	1 ea., 10 pieces in total

HSC_{type} (Slit Collet Type)

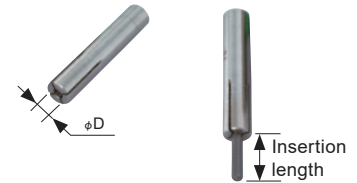

CODE	φD
HSC-D [Ex : HSC-6]	3, 3.175 [1/8"], 4, 6



Caution

•HSA type cannot be used with HEAT ROBO DENJI.

Insertion

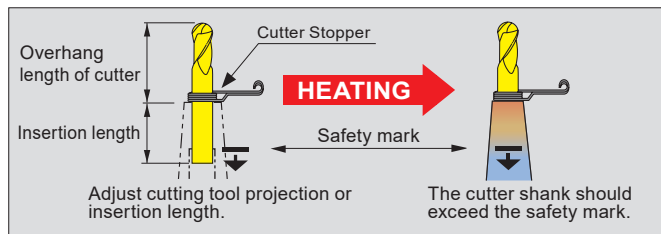

Removing

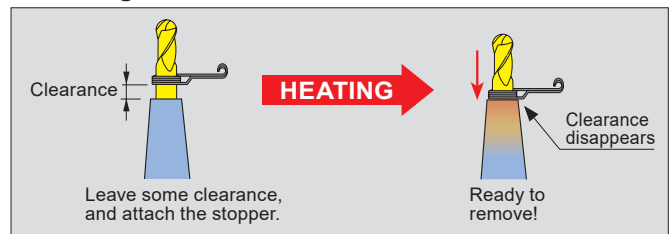

Cutter Pliers

Heat-resistant gloves are not required to perform the simple shrink-fit operation.

CODE
HPY-01

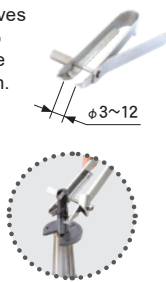

Stopper Pliers

Easy to attach and detach for HSB type.

CODE
SPY-01

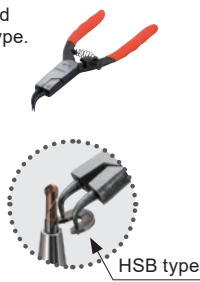

Cutter Tray

Cooling Tray for heated cutting tools after removal from a holder.

CODE
SDH-01

Size:170×170 (mm)



Heat-resistant gloves

For additional order

CODE	NOTE
HTB-01	—
-01-R	Right Hand
-01-L	Left Hand



Holder Stand

The stand for the SLIMLINE collet, straight arbor and small shank holders (HSK-E25 and E32) is available in four colors, enabling simple color-coding.

CODE	Color	Front face	Back face	max. Q'ty
SDKT-RE	RED	SLIMLINE collet STRAIGHT arbor	Small shank holders (HSK-E25 / E32)	25 pieces each
-BL	BLUE			
-GR	GREEN			
-GD	GOLD			

Size:190×190 (mm)

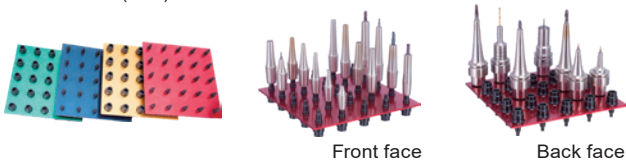

Cutter Adjuster

Simply adjustment for cutting tool projection and insertion length.

CODE	φD	L
HAJ-3	3	10~ 30
-3.175	3.175 [1/8"]	
-4	4	13~ 30
-3/16	[3/16"]	
-6	6	19~ 45
-1/4	[1/4"]	
-8	8 [5/16"]	21~ 55
-10	10 [3/8"]	22~ 70
-12	12	23~ 85
-1/2	[1/2"]	
-16	16 [5/8"]	26~ 90
-20	20 [3/4"]	37~100
-25	25	40~100
-1"	[1"]	

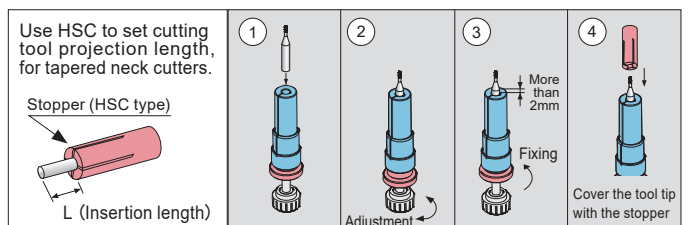
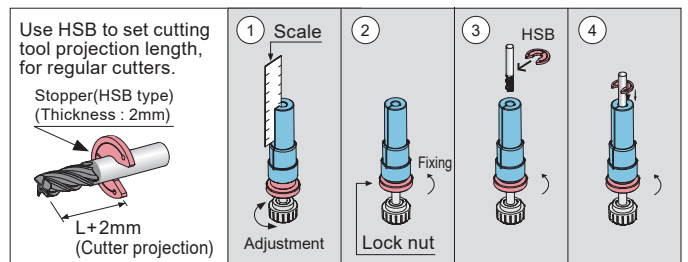
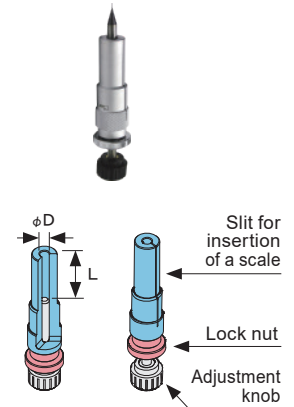

■ Cleaning tools

■ Brush type

Nylon brushes for internal bores cleaning.

CODE	I.D
AQC-BR -SET	3 [1/ 8"], 4 [3/16"], 6 [1/4"], 8 [5/16"], 10 [3/ 8"], 12 [1/2"], 1 of each. 6 pieces in total
-BR 3-5	3 [1/ 8"], 5 pcs.
-BR 4-5	4 [3/16"], 5 pcs.
-BR 6-5	6 [1/ 4"], 5 pcs.
-BR 8-5	8 [5/16"], 5 pcs.
-BR10-5	10 [3/ 8"], 5 pcs.
-BR12-5	12 [1/ 2"], 5 pcs.

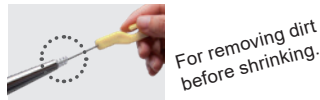

■ **Caution**
• Do not use when holder is hot.

■ Rubber grinding stone type

To eliminate strong oxidized film and burned-in dust and oil that have been generated in the internal bores.

Standard set

CODE	NOTE
CLT-GTA-01	1 ea. of right model

Parts

CODE	NAME	φd	Q'ty
CLT-GTA-GP	Grip	—	1
-GTA 3-5	Rubber grindstone	3	5
-GTA 4-5		4	5
-GTA 6-5		6	5
-GTA 8-5		8	5
-GTA10-5		10	5

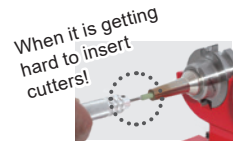

■ Aqua Cool

■ Aqua cool kit

Cooling kit for cooling SLIMLINE holders after shrink fitting or removing.

CODE	NOTE
AQC-KIT-01	1 ea. for below model

Parts

CODE	NAME	NOTE
AQC-EK-01-2	Special Liquid	2l of undiluted Solution, Use at a dilution ratio of 3%.
-AT-01	Aqua Tray	Drainer plate
-AH-01	Adapter Hanger	Hanger for lowering holders into liquid.
CN -245	Container Box	Size:424×291×245 (364×242×230) mm
-FT	Lid for Container Box	Size:421×288×35 mm

() inside dimension

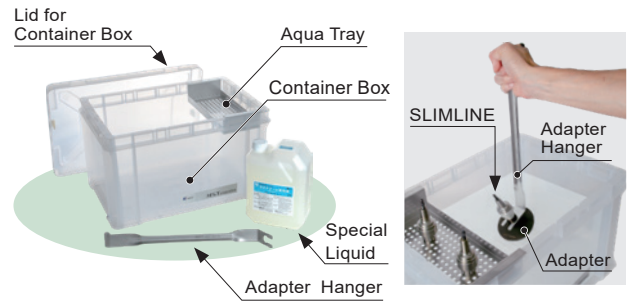

■ A shrink-fitting work efficiency kit, Shrink-fit holder Chiller

Shrink fitting operation can be shortened. Installation is easy as no power supply is required. All MST's heating devices are available.

■ Shrink-fit holder Chiller A type For Induction Heaters and Hot Air Heaters

CODE	Cooling tower	Ⓚg
CWBA01	1 pc.	18
CWBA02	2 pcs.	25

■ Std. Access.

- Slide table
- Slide type base(3 pcs.)
- Stopper ring(6 pcs.)
- Thermo seal(7 pcs.)
- Connecting air tube (dia.8mm, length 2m)

■ Note

- Compressed air required: 0.5MPa (air-consumption volume: 245 l/min)
- Please connect the air line that came with the unit. (Supply air pressure: 0.5~0.7MPa)

CWBA01

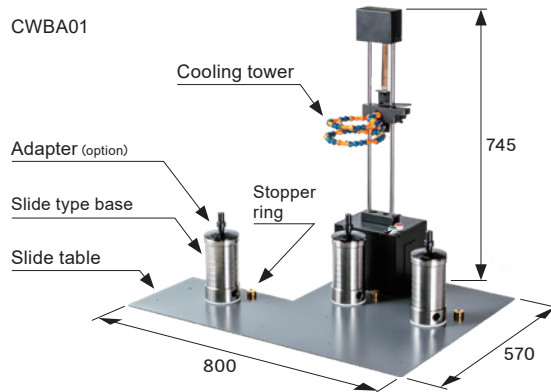

CWBA02
(Installed 2 cooling towers)

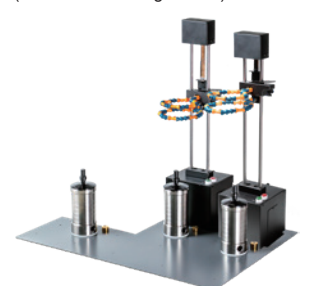

REPLACEMENT PARTS

Cooling tower (For additional orders)

CODE
CTW01



Slide table

CODE
SLT01

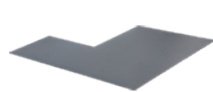

Slide type base

CODE
BAA-01SL



Stopper ring

CODE	Q'ty
SRG01	2

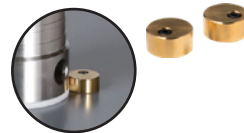

Thermo seal

CODE	Q'ty
THR60	7

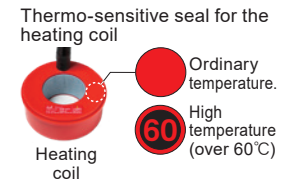

■ Shrink-fit holder Chiller B type

Compact type that can be installed in tight spots.

CODE	Ⓚg
CWBB01	7.3

■ Std. Access.

- Thermo seal(7 pcs.)
- Connecting air tube (dia.8mm, length 2m)

■ Note

- Compressed air required : 0.5MPa (air-consumption volume : 245l/min)
- Please connect the air line that came with the unit. (Supply air pressure : 0.5~0.7MPa)

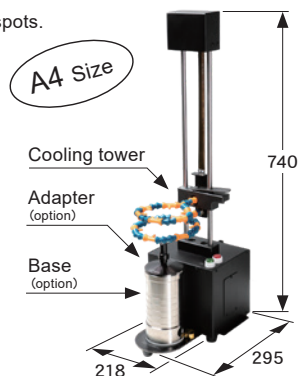

■ Shrink-fit holder Chiller C type For Hot Air Heaters

For HEAT ROBO Baby 3000S/1200S.

CODE	Ⓚg
CWBC01	7.2

■ Note

- Compressed air required : 0.5MPa (air-consumption volume : 245 l/min)
- Prepare an air tube (O.D. : 8mm) and a connection coupling.

